



# Integrated Report 2020

For the year ended March 31, 2020



# 社 是

一、信用を尊び責任を重んず

一、虚飾を排し和衷協力誠実事に當る

一、研究と創造に努め常に時流に先んず

一、最善の品質とサービスを以て社会に奉仕す

The DENSO Creed

“Be trustworthy and responsible.”

“Cherish modesty, sincerity, and cooperation.”

“Be pioneering, innovative, and creative.”

“Provide quality products and services.”

## DENSO Philosophy

Contributing to a better world  
by creating value together with  
a vision for the future

## DENSO Spirit

A spirit of foresight, credibility and collaboration

The DENSO Spirit expresses values and beliefs shared by our employees around the world that have driven us to contribute to the automotive industry and society as a whole since our establishment in 1949.

### Foresight

Providing surprises and impressions in a way that only DENSO can

Vision

Creativity

Challenge

### Credibility

Providing quality and reliability beyond customer expectations

Quality First

On-site Verification

*Kaizen,*  
Continuous Improvement

### Collaboration

Achieving the highest results by working as a team

Communication

Teamwork

Human Development

# CONTENTS

DENSO Integrated Report 2020

## Editorial Policy

In addition to providing financial information, such as results and sales overviews as well as management strategy, *DENSO Integrated Report 2020* is edited as an integrated report that reports, in an easily understood manner, on what value DENSO is providing society and on the process of improving that corporate value. This we achieved by introducing, in an integrated manner, information of a non-financial nature on intangible assets, including on the environment, society and governance (ESG), that are seen as the foundation underpinning growth.

DENSO creates long-term corporate value for all of its stakeholders, including shareholders and other investors, and would appreciate their understanding for the efforts the Company is making in aiming to realize a sustainable society.

In compiling this report, references have been made to the “international integrated reporting framework” that is proposed by the International Integrated Reporting Council (IIRC), as well as the “Guidance for Integrated Corporate Disclosure and Company-Investor Dialogue for Collaborative Value Creation,” formulated by the Ministry of Economy, Trade and Industry. In addition, with regard to social reporting and the environment, please refer to the “Sustainability” section of the Company’s website.

## Scope of Report

Target Organization  
DENSO CORPORATION and the DENSO Group (In this report, DENSO CORPORATION refers to DENSO on a non-consolidated basis.)

## Reporting Period

This report covers the activities of the DENSO Group during fiscal 2020 (April 1, 2019 to March 31, 2020). Certain parts of this report include content on the Group’s activities from April 2020 onward.

## Target Audience

All stakeholders involved with the DENSO Group

## Cautionary Note: Forward-Looking Statements

Of the content published in this report, what is not historical fact comprises future predictions based on expectations or on plans for the future. As they include contributory factors, such as risks and uncertain elements, the possibility exists that actual achievements and results may differ materially from this report.

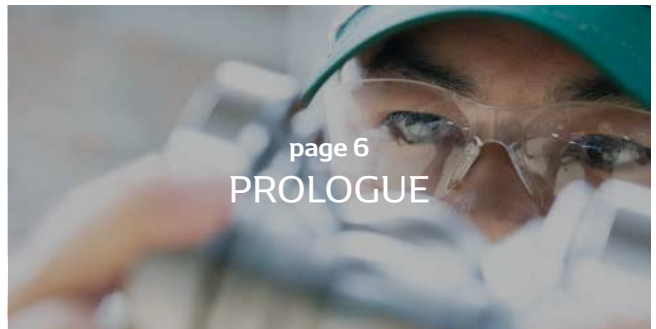

- 6 Creating a Brighter Future for Mobility
- 8 The Challenges We Face: A Once-in-a-Century Paradigm Shift in the Mobility Society
- 10 Our Determination: Surviving the Paradigm Shift and Paving the Way for the Future Mobility Society

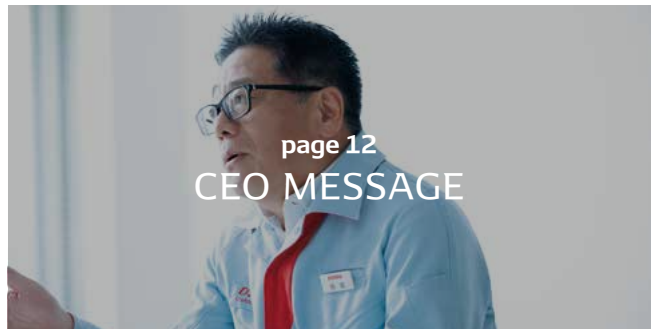

- 12 To Our Stakeholders

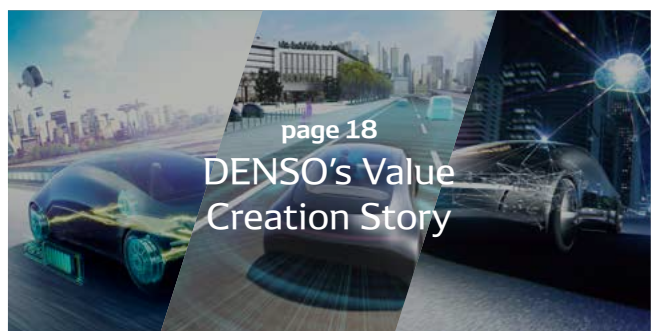

- 18 Past, Present, and Future
- 20 STORY 1 Cultivated Strengths
- 22 STORY 2 Our Accumulated Capitals
- 24 STORY 3 Creating New Value through Our Six Core Businesses
- 26 DENSO's Value Creation Process



page 28  
Growth Strategy

- 29 Awareness of Business Environment
- 32 Outline of Management Policies
- 33 **1** Long-term Policy
- 34 **2** Materiality
- 35 **3** Long-term Plan
- 36 Mid-term Plan and DENSO Revolution Plan "Reborn21"
- 38 Efforts to Maximize the Value of "Green"



page 62  
Overview by Product

- 63 Business Portfolio and Value Creation
- 64 Thermal Systems
- 66 Powertrain Systems
- 68 Electrification Systems
- 70 Mobility Electronics
- 72 Sensors & Semiconductors
- 74 Non-Automotive Businesses (FA and Agriculture)



page 41  
Foundation for Creating New Value

- 42 Reinforcing Our Strengths
  - 42 Research and Development
  - 44 *Monozukuri*
  - 46 *Hitozukuri*
- 48 Strengthening Capitals
  - 48 Financial Capital
    - 50 CFO Message
  - 54 Human Capital
  - 56 Manufacturing Capital
    - 57 CQO Message
  - 58 Intellectual Capital
  - 59 Social and Relationship Capital
- 61 Strengthening Our Organizational Capabilities



page 78  
Corporate Governance

- 79 Corporate Governance
- 86 Dialogue with the Outside Directors
- 90 Directors and Audit & Supervisory Board Members
- 92 Risk Management
  - 92 CRO Message
- 94 Compliance



page 95  
Corporate Data

- 96 Facts & Figures
- 98 10-Year Data
- 100 Company Overview and Stock Information

Positioning of Integrated Report



Please see DENSO's corporate website for PDF format.  
<https://www.denso.com/global/en/about-us/investors/annual-report/>

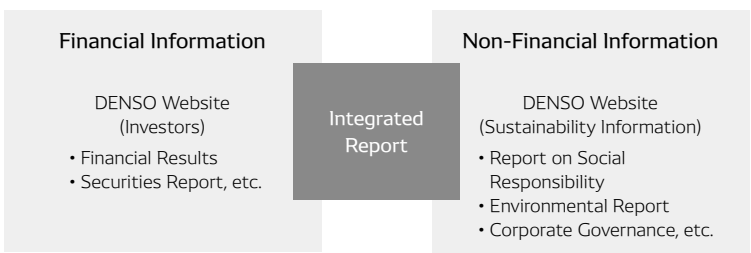

TCFD INDEX



DENSO has pledged its support for the Task Force on Climate-related Financial Disclosures (TCFD). For *DENSO Integrated Report 2020*, we referenced the climate-related disclosure items recommended by the TCFD. The table below shows the correspondence between the TCFD recommended disclosure items within this report and the ones on our corporate website. Furthermore, this integrated report includes sections that disclose opportunities and risks based on scenario analysis and summarize DENSO's initiatives in accordance with the TCFD recommendations. Please see page 38 for details. The table below mainly includes excerpts on these topics from pages other than page 38.

	DENSO Integrated Report 2020	DENSO's Corporate Website
Governance	a) Describe the Board's oversight of climate-related risks and opportunities	
	P40: Efforts to Maximize the Value of "Green" >Governance P80: Corporate Governance >Corporate Governance System	Who we are>Sustainability>Corporate Governance>Corporate Governance System and Principal Organizations: <a href="https://www.denso.com/global/en/about-us/sustainability/governance/management/">https://www.denso.com/global/en/about-us/sustainability/governance/management/</a> Who we are>Sustainability>Sustainability Management>Promotion structure: <a href="https://www.denso.com/global/en/about-us/sustainability/management/">https://www.denso.com/global/en/about-us/sustainability/management/</a> Who we are>Sustainability>Commitment to the Environment>EcoVision>Environmental Management (Eco-Management)>Promotion Structure: <a href="https://www.denso.com/global/en/about-us/sustainability/environment/ecovision/eco-management/">https://www.denso.com/global/en/about-us/sustainability/environment/ecovision/eco-management/</a>
Governance	b) Describe management's role in assessing and managing climate-related risks and opportunities	
	P40: Efforts to Maximize the Value of "Green" >Governance P80: Corporate Governance >Corporate Governance System	Who we are>Sustainability>Corporate Governance>Corporate Governance System and Principal Organizations: <a href="https://www.denso.com/global/en/about-us/sustainability/governance/management/">https://www.denso.com/global/en/about-us/sustainability/governance/management/</a> Who we are>Sustainability>Sustainability Management>Promotion structure: <a href="https://www.denso.com/global/en/about-us/sustainability/management/">https://www.denso.com/global/en/about-us/sustainability/management/</a> Who we are>Sustainability>Commitment to the Environment>EcoVision>Environmental Management (Eco-Management)>Promotion Structure: <a href="https://www.denso.com/global/en/about-us/sustainability/environment/ecovision/eco-management/">https://www.denso.com/global/en/about-us/sustainability/environment/ecovision/eco-management/</a>
Strategy	a) Describe the climate-related risks and opportunities the organization has identified over the short, medium, and long term	
	P29-31: Social Changes as of 2030, Major Issues for DENSO Based on Risks and Opportunities P34: Materiality P38-40: Efforts to Maximize the Value of "Green" >Scenario Analysis of Business Opportunities and Risks, Strategies, Indicators, and Targets	Who we are>Sustainability>Sustainability Management>Materiality: <a href="https://www.denso.com/global/en/about-us/sustainability/materiality/">https://www.denso.com/global/en/about-us/sustainability/materiality/</a> Who we are>Sustainability>Commitment to the Environment>EcoVision: <a href="https://www.denso.com/global/en/about-us/sustainability/environment/ecovision/">https://www.denso.com/global/en/about-us/sustainability/environment/ecovision/</a> Who we are>Sustainability>Commitment to the Environment>Environmental Action Plan: <a href="https://www.denso.com/global/en/about-us/sustainability/environment/action-plan/">https://www.denso.com/global/en/about-us/sustainability/environment/action-plan/</a>
	b) Describe the impact of climate-related risks and opportunities on the organization's businesses, strategy, and financial planning	
Strategy	P29-31: Social Changes as of 2030, Major Issues for DENSO Based on Risks and Opportunities P32: Outline of Management Policies P33: Long-term Policy P34: Materiality P35: Long-term Plan P36-37: Mid-term Plan and DENSO Revolution Plan "Reborn21" P38-40: Efforts to Maximize the Value of "Green" >Scenario Analysis of Business Opportunities and Risks, Strategies, Indicators, and Targets	Who we are>Corporate Information>Philosophy>Long-term Policy: <a href="https://www.denso.com/global/en/about-us/corporate-info/philosophy/long-term-policy/">https://www.denso.com/global/en/about-us/corporate-info/philosophy/long-term-policy/</a> Who we are>Sustainability>Sustainability Management>Materiality: <a href="https://www.denso.com/global/en/about-us/sustainability/materiality/">https://www.denso.com/global/en/about-us/sustainability/materiality/</a> Who we are>Sustainability>Commitment to the Environment>EcoVision: <a href="https://www.denso.com/global/en/about-us/sustainability/environment/ecovision/">https://www.denso.com/global/en/about-us/sustainability/environment/ecovision/</a> Who we are>Sustainability>Commitment to the Environment>Environmental Action Plan: <a href="https://www.denso.com/global/en/about-us/sustainability/environment/action-plan/">https://www.denso.com/global/en/about-us/sustainability/environment/action-plan/</a> What we do>Innovation: <a href="https://www.denso.com/global/en/business/innovation/">https://www.denso.com/global/en/business/innovation/</a> What we do>Innovation>Biotechnology (Micro Algae) (Japanese only): <a href="https://www.denso.com/jp/ja/business/products-and-services/other-industries/industry/bio/">https://www.denso.com/jp/ja/business/products-and-services/other-industries/industry/bio/</a>
	c) Describe the resilience of the organization's strategy, taking into consideration different climate-related scenarios, including a 2°C or lower scenario	
	P38-40: Efforts to Maximize the Value of "Green" >Scenario Analysis of Business Opportunities and Risks	
Risk Management	a) Describe the organization's processes for identifying and assessing climate-related risks	
	P34: Materiality P40: Efforts to Maximize the Value of "Green" >Risk Management P92-93: Risk Management	Who we are>Sustainability>Sustainability Management>Materiality: <a href="https://www.denso.com/global/en/about-us/sustainability/materiality/">https://www.denso.com/global/en/about-us/sustainability/materiality/</a> Who we are>Sustainability>Commitment to the Environment>Environmental Management (Eco-Management) >Promoting Consolidated Environmental Management, Environmental Risk Management: <a href="https://www.denso.com/global/en/about-us/sustainability/environment/ecovision/eco-management/">https://www.denso.com/global/en/about-us/sustainability/environment/ecovision/eco-management/</a> Who we are>Sustainability>Corporate Governance>Risk Management: <a href="https://www.denso.com/global/en/about-us/sustainability/governance/risk/">https://www.denso.com/global/en/about-us/sustainability/governance/risk/</a>
	b) Describe the organization's processes for managing climate-related risks	
Risk Management	P34: Materiality P40: Efforts to Maximize the Value of "Green" >Risk Management P92-93: Risk Management	Who we are>Sustainability>Sustainability Management>Materiality: <a href="https://www.denso.com/global/en/about-us/sustainability/materiality/">https://www.denso.com/global/en/about-us/sustainability/materiality/</a> Who we are>Sustainability>Commitment to the Environment>Environmental Management (Eco-Management) >Promoting Consolidated Environmental Management, Environmental Risk Management: <a href="https://www.denso.com/global/en/about-us/sustainability/environment/ecovision/eco-management/">https://www.denso.com/global/en/about-us/sustainability/environment/ecovision/eco-management/</a> Who we are>Sustainability>Corporate Governance>Risk Management: <a href="https://www.denso.com/global/en/about-us/sustainability/governance/risk/">https://www.denso.com/global/en/about-us/sustainability/governance/risk/</a>
	c) Describe how processes for identifying, assessing, and managing climate-related risks are integrated into the organization's overall risk management	
	P40: Efforts to Maximize the Value of "Green" >Risk Management	Who we are>Sustainability>Corporate Governance>Risk Management: <a href="https://www.denso.com/global/en/about-us/sustainability/governance/risk/">https://www.denso.com/global/en/about-us/sustainability/governance/risk/</a>
Metrics and Targets	a) Disclose the metrics used by the organization to assess climate-related risks and opportunities in line with its strategy and risk management process	
	P40: Efforts to Maximize the Value of "Green" >Strategies, Indicators, and Targets	Who we are>Sustainability>Commitment to the Environment>EcoVision: <a href="https://www.denso.com/global/en/about-us/sustainability/environment/ecovision/">https://www.denso.com/global/en/about-us/sustainability/environment/ecovision/</a>
	b) Disclose Scope 1, Scope 2, and, if appropriate, Scope 3 greenhouse gas (GHG) emissions, and the related risks	
Metrics and Targets	P97: Non-Financial Highlights>CO <sub>2</sub> Emissions per Unit (Non-Consolidated) P98-99: 10-Year Data>Non-Financial Data>CO <sub>2</sub> Emissions per Unit (Non-Consolidated), CO <sub>2</sub> Emissions per Unit (Domestic and Overseas Group)	Who we are>Sustainability>Commitment to the Environment>Data compilation (Environmental report): <a href="https://www.denso.com/global/en/about-us/sustainability/library/environment-data/">https://www.denso.com/global/en/about-us/sustainability/library/environment-data/</a>
	c) Describe the targets used by the organization to manage climate-related risks and opportunities and performance against targets	
	P40: Efforts to Maximize the Value of "Green" >Strategies, Indicators, and Targets P98-99: 10-Year Data>Non-Financial Data>CO <sub>2</sub> Emissions per Unit (Non-Consolidated), CO <sub>2</sub> Emissions per Unit (Domestic and Overseas Group)	Who we are>Sustainability>Commitment to the Environment>Environmental Action Plan: <a href="https://www.denso.com/global/en/about-us/sustainability/environment/action-plan/">https://www.denso.com/global/en/about-us/sustainability/environment/action-plan/</a> Who we are>Sustainability>Commitment to the Environment>Data compilation (Environmental report): <a href="https://www.denso.com/global/en/about-us/sustainability/library/environment-data/">https://www.denso.com/global/en/about-us/sustainability/library/environment-data/</a>

## Overall Layout of *DENSO Integrated Report 2020*

This integrated report is edited based on the layout explained in the chart below. This layout is used to better explain DENSO's value creation story.

The aim of *DENSO Integrated Report 2020* is to have the reader gain a deep understanding of DENSO's value creation process while promoting an opportunity for dialogue. Throughout the entirety of this booklet, we have created a story line that comprehensively communicates our value creation process while encompassing crucial elements that help the reader understand this process (management philosophy, business model, strategy, governance, etc.). The chart below shows the logical layout of these crucial elements based on the story line we have created. Additionally, we have created an index of keywords affiliated with each element so that readers can easily access the information they wish to know.

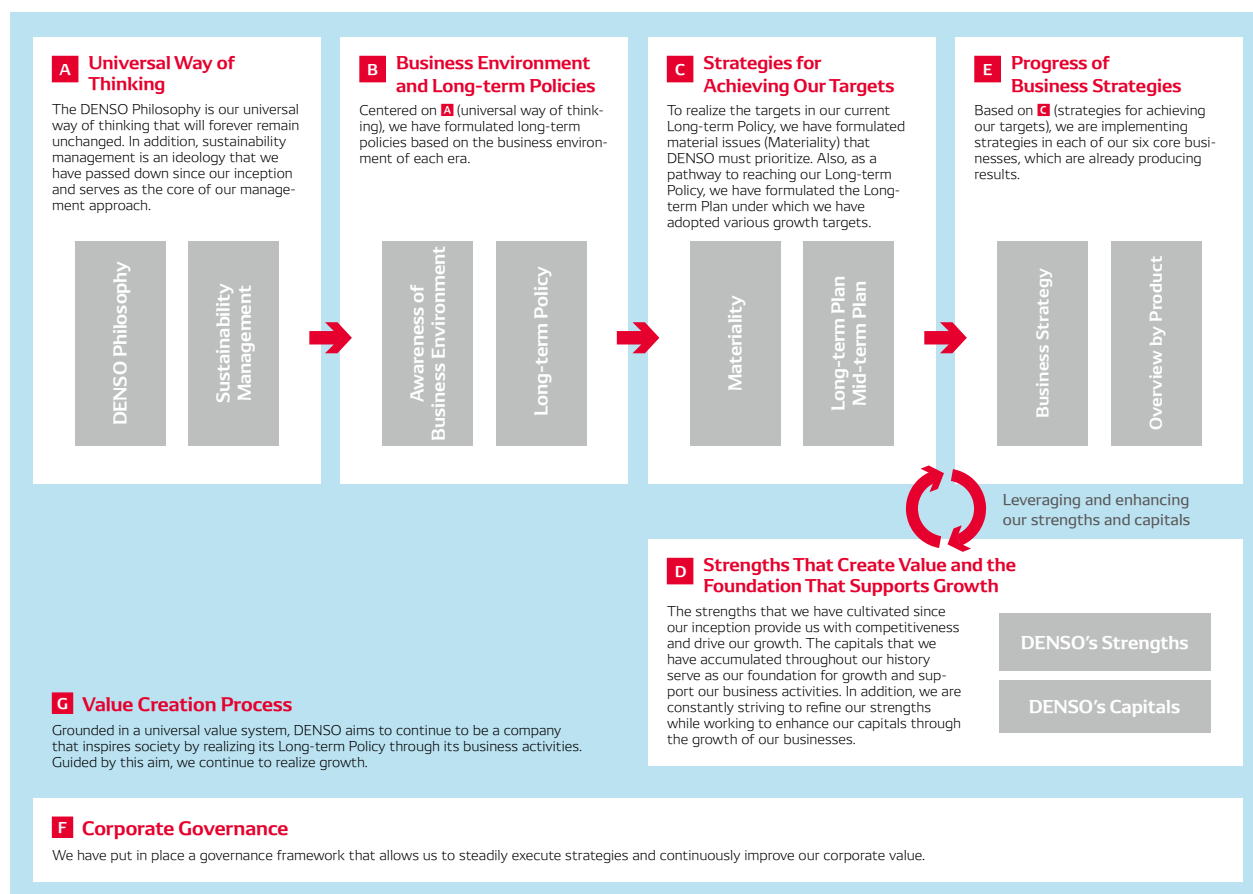

<b>A</b> DENSO Philosophy ..... P.1	<b>D</b> DENSO's Strengths (Overview) ..... P.20–21
Sustainability Management ..... P.18–27, 32–40	DENSO's Capitals (Overview) ..... P.22–23
<b>B</b> Awareness of Issues During the Paradigm Shift (Overview) ..... P.8–9	Reinforcing Our Strengths ..... P.42–47
CEO Approach and Vision Based on the Business Environment ..... P.12–17	Strengthening Capitals ..... P.48–61
Awareness of the Business Environment (PEST Analysis) ..... P.29–31	<b>E</b> DENSO's Businesses (Overview) ..... P.24–25
Risks and Opportunities and Response Measures ..... P.30	Business Portfolio and Value Creation ..... P.63
Major Issues for DENSO ..... P.31	Strategies and Outlook for Each Business ..... P.64–77
Long-term Policy ..... P.33	Facts & Figures ..... P.96–97
Scenario Analysis on Climate Change ..... P.38	<b>F</b> Efforts to Improve Corporate Governance ..... P.79
Identification of Climate-Related Opportunities and Risks and Response Measures ..... P.39–40	Corporate Governance System ..... P.80–83
<b>C</b> DENSO's Initiatives to Resolve Issues (Overview) ..... P.10–11	Compensation of Directors and Audit & Supervisory Board Members ..... P.84
Outline of Management Policies ..... P.32	Strategic Shareholdings ..... P.85
Growth Indicators to Realize the Long-term Policy and Social Issues We Aim to Resolve ..... P.33	Dialogue with the Outside Directors ..... P.86–89
Materiality ..... P.34	Directors and Audit & Supervisory Board Members ..... P.90–91
Related SDGs ..... P.34	Risk Management ..... P.92–93
Long-term Plan ..... P.35	Compliance ..... P.94
Mid-term Plan ..... P.36–37	<b>G</b> DENSO's Value Creation Process ..... P.26–27
Financial Strategies ..... P.48–53	Crucial Elements of the Value Creation Process ..... P.18–25
Efforts toward Quality ..... P.57	

PROLOGUE

# Creating a Brighter Future for Mobility

Amid the dramatic changes occurring in society,  
DENSO is dealing with a crisis unlike any it has experienced before.

Entering into the 70th year since its founding,

DENSO will once again return to its origins  
in an effort to be reborn for the future of mobility.

By doing so, DENSO will overcome the current difficult situation it is facing.





# Reborn for the Future of Mobility

The Challenges We Face

# A Once-in-a-Century Paradigm Shift in the Mobility Society

The world is approaching the time of a paradigm shift in which the values of society itself are dramatically changing due to such factors as technological advancements, which are occurring at remarkable speeds, the rapid progression of digitization, and the impact of the COVID-19 pandemic. In the mobility domain, the impact of this paradigm shift is giving rise to drastic reforms that are changing the way we think about automobiles themselves.

## DENSO's Awareness of Issues

# Drastic Reforms to Mobility Due to the Rapid Progression of Information and Intelligence-based Functions

The mobility society is undergoing tremendous changes due to the rapid evolution of IoT and AI. Amid these circumstances, it is essential to create value that goes beyond the conventional automobile domain and focuses on the new mobility society.

## Changes to Social Values Due to the COVID-19 Pandemic

COVID-19 has the potential to substantially change conventional social values. It is therefore important that we observe such changes, ascertain what they mean for our business, and clarify what we can do in response.

# Paradigm Shift

## The Increasingly More Challenging Business Environment and Intensifying Competition

The business environment surrounding DENSO is becoming increasingly more challenging due to COVID-19 and the unconventional entry of major players from other industries into the automotive industry. Under these circumstances, we recognize that the era of steady sales growth is coming to an end, and we must now transform our management structure so that we are able to respond to whatever changes that may occur in the business environment.

## The Pressing Crisis of Climate Change

Amid growing concerns over climate change around the world, including record-high temperature increases and the frequent occurrence of large-scale natural disasters, discovering the ideal form for mobility that underpins a sustainable society has become an urgent issue in the automotive industry, which has a significant impact on the environment.

**Our Determination**

# Surviving the Paradigm Shift and Paving the Way for the Future Mobility Society

To control the turbulent business environment and provide  
a better future for the next generation,

DENSO will thoroughly reform its corporate structure to be more resilient to change.  
At the same time, DENSO will enhance its competitiveness so that it can contribute  
to the future mobility society in domains that transcend automobiles.

By doing so, DENSO will maximize the value that it offers society.

## DENSO's Initiatives

### Maximizing the Value of Green and Peace of Mind to Be Inspiring

DENSO recognizes that its greatest task is to maximize the value of green and peace of mind to be inspiring. Accordingly, we aim to contribute to the realization of a future mobility society by creating value in these domains.

### Leveraging Our Strengths to Create a Future Mobility Society

In the CASE era, there is a need for a large-scale system evolution that shifts the focus from mechanical parts to software. To that end, DENSO will go beyond the traditional automobile domain to create value through the establishment of an integrated system based on the three pillars of software, mechanical parts, and electronics while leveraging its long-cultivated strengths with a view to realizing a future mobility society.

# Crafting the Core

### Returning to Our Origins to Transform DENSO into a Company with Greater Substance and Value

Amid the increasingly challenging business environment, we will enhance the substance of our strategies—quality, craftsmanship, human resources, and organization—rather than pursue quantity. While doing so, we will reform our corporate structure so that we are more resilient to change.

### Accelerating Sustainability Management

To overcome the paradigm shift and provide a better future for the next generation, we will reaffirm our significance to society as we accelerate sustainability management—the management ideology we have adopted since our founding—going forward.

# CEO MESSAGE

To Our Stakeholders



Koji Arima  
President & CEO

# Starting Anew with the Aim of Realizing a Mobility Society Led by People

DENSO has been impacted by the sudden changes in the external environment, the COVID-19 pandemic, and the quality-related issue that recently occurred at the Company. Under these circumstances, DENSO is currently pursuing dramatic management reform. To that end, DENSO will push forward with Companywide efforts to return to the origins of its foundation, accomplish a transition from “quantity to quality,” and start anew in fiscal 2022 by realizing a genuine self-transformation.

I would first like to offer my condolences to the families and friends of those who have passed away due to the COVID-19 pandemic. I would also like to extend my thoughts and prayers to all those who have been impacted by this pandemic. I sincerely hope that those who have contracted the virus make a full recovery and that the world will return to normal as quickly as possible. Furthermore, I would like to express my deepest gratitude to the medical professionals working on the front lines to save lives and those working to maintain critical social infrastructure.

In regard to measures to respond to the COVID-19 pandemic, in January 2020 we established the COVID-19 Response Headquarters, which is led by the chief risk officer (CRO). Through this headquarters, we have been working to gather the latest information related to the pandemic from around the world. We have also been enacting global countermeasures led by our head office while giving consideration to the conditions in each country and region of operation.

Our top priority is protecting the safety of our employees and their families around the world. To that extent, we have been rigorously enforcing measures to prevent the spread of COVID-19, including having employees take their temperature every morning before reporting to work, avoiding crowding together in company offices and cafeterias, standardizing teleworking, and prohibiting business trips and in-house events.

To help make masks more available to society, we promoted efforts to produce masks in-house to achieve self-sufficiency in terms of the masks that Group employees use. While this represented a first-time effort for us, we were able to leverage our insight as a manufacturing company to internalize all processes relating to mask production. By doing so, we have already been able to transition to a structure for the mass production of masks.

Meanwhile, as a direct social contribution, employees at our bases both in Japan and overseas took the initiative to produce medical-use face shields and provide them to local hospitals free of charge. Witnessing this activity, not only do I feel proud that we are a manufacturing company, I also feel reassured in knowing that such great people belong to the DENSO Group.

## Recommitting to “DENSO Quality” with Strong Determination and Readiness

I once again would like to apologize for the great deal of trouble we have caused our end-users, car manufacturers, and other related parties due to the occurrence of the recent quality-related issue. We are taking this issue extremely seriously, as it may likely cause us to lose the trust of our customers, which we have built up over many years.

## CEO MESSAGE

Rather than viewing the series of events that led to a specific problem affecting a certain product, I recognize it as an opportunity to further improve and evolve our Companywide culture and stance.

People may start to wonder if we changed our order of priority from “safety, quality, profit, quantity” to “quantity, profit, safety, quality.” People may also question whether we expanded production without sufficiently examining issues and limitations related to our existing production lines. We recognize that all of the products and services we produce fulfill an important role for our customers as they relate directly to peace of mind and security. Quality is our lifeline and serves as the starting point for us as a company. Going forward, all members of management and all employees will fulfill their respective responsibilities, seriously and earnestly reflecting on the current situation. In this way, we will recommit ourselves to “DENSO Quality” with strong determination and readiness.

### **Viewing the Current Crisis as an Opportunity to Promote Dramatic Reforms**

For the past several years, I have been emphasizing how we are facing some of the most severe changes in the external environment since our founding. I have also been reiterating the fact that, under these circumstances, we will soon find it difficult to survive if we only adhere to the approaches we have promoted in the past. Never before have we felt a sense of crisis so vividly as we are feeling now under the current situation. At this time, we are simultaneously experiencing a paradigm shift, which occurs once every 100 years in the automotive industry, brought about by the CASE revolution, and a global pandemic with COVID-19, which is also an event that occurs once every 100 years. Additionally, as a specific issue to DENSO, the largest-ever quality-related issue in our history has been discovered, and, as a result, we find ourselves in a situation where we have significantly shaken the trust of our customers. With this overlap of profoundly challenging circumstances, we find ourselves in a critical life-or-death situation as a company, and we can no longer afford to wait for the promotion of dramatic reforms. In light of these circumstances, we established the position of chief corporate revolution officer (CCRO), who is in charge of promoting dramatic reforms to our corporate structure, in June 2020. Significant responsibility and authority has been given to the CCRO for all matters pertaining to corporate reforms.

Furthermore, we formed a Groupwide reform task force whose members were selected personally by the CCRO. Through these efforts, we will revise from the ground up everything from the formulation of our business strategies and the vision for our personnel and organization to the way we promote cost management and capital expenditures. In this manner, we will pursue reforms to all aspects of the Company without exception. For the sake of our stakeholders, including our customers, suppliers, local community members, and employees, we will overcome these hardships with strong determination to survive as a company.

While the reality of the situation is that we are facing an extremely difficult task, I also believe that these circumstances present us with significant opportunities. In the “With COVID-19” and “Post-COVID-19” world, new value systems have emerged in society and the automotive industry, and these value systems have tied in with the digital revolution. This, in turn, has started to bring about an entirely new situation. In terms of the CASE revolution, we anticipate a slowdown in the trend of sharing (S), while needs related to autonomous (A), electric (E), and especially connected (C) will likely increase in the future. These trends bring with them significant business opportunities. We see the potential that these new environmental changes offer, and we must draw on this potential to achieve a genuine self-transformation. Truly, these circumstances represent a once-in-a-lifetime opportunity.

Due to the COVID-19 pandemic, we have brought ourselves to a halt, and this has allowed us to see various aspects of our situation from completely new angles. Under this environment, we have the opportunity to push forward with sweeping management reforms that we would never have been able to pursue under normal circumstances. To ensure that we can start anew as a “Reborn DENSO” in fiscal 2022, we will make Companywide efforts to accomplish these reforms.

### **Creating a Path toward Growth by Transitioning from “Quantity to Quality” and Establishing Partners**

After the global financial crisis, we worked diligently to secure a lean corporate structure on a Groupwide basis. However, before we knew it, we had fallen into a way of thinking that placed quantity over quality, which in turn led us to become a company with an excessive amount of fixed expenses. To improve earning power, we need to be able to earn even if



quantity decreases. To that end, under the current state of emergency, we will first promptly realize the goals of “recommitting to quality” and “preventing the further deterioration of our performance in the near term.” We will also make concerted efforts to transition to a lean and robust corporate structure that will enable us to realize profits even if sales decline. At the same time, under the slogan “Reborn21,” we will strive to become a company that is truly useful to its customers and society as a whole by maximizing the value of “green” and “peace of mind.” Guided by this ambition, we will significantly revise our strategies, the way we promote our work, and our vision for our personnel and organization as we transform ourselves into a company with even higher added value.

Furthermore, we will not be able to promptly achieve our ambition of being truly useful to our customers and society as a whole with our strengths as a company alone. For that reason, it is extremely important that we strengthen collaboration with like-minded partners. The Toyota Group is currently working to restructure its businesses through its new “home & away strategy.” To date, companies belonging to the Toyota Group have worked to refine their respective capabilities while striving to mutually enhance one another. Under the “home & away strategy,” the Toyota Group aims to gather together these capabilities on a groupwide level, leveraging the respective strengths (home) of each group company to maximize the power of the group as a whole. As a result of doing so, each group company will be able to create a path for growth from the perspective of groupwide optimization. For example, in the electrification field, we established BluE Nexus Corporation, a joint venture with Aisin Seiki Co., Ltd. that develops and sells driving module packages, in April 2019. Additionally, we consolidated Toyota Motor Corporation’s electronic component business within DENSO in April 2020, relaunching the business as the DENSO Hirose Plant. For the automation field, in April 2019 four companies of the Toyota Group, including DENSO, worked together to establish the new joint venture J-QuAD DYNAMICS. In April 2020, we established MIRISE Technologies, a joint venture with Toyota Motor that conducts R&D activities on next-generation in-vehicle semiconductors.

Although these initiatives have just started to get underway, we can already feel the significance of these efforts within the Company, as they involve combining the strengths of the Toyota Group to maximize the Group’s overall power amid the significant change occurring in the automotive industry, which is making it difficult to forecast the future.



With an understanding of this significance, DENSO is working to accelerate activities under the “home & away strategy.”

Meanwhile, it is also important that we collaborate with players outside of the Toyota Group. To that end, we have established four satellite R&D bases around the world, including in the United States and Israel, and through these bases we are currently pursuing collaboration with local research institutions and start-up companies. Going forward, it is imperative that we further enhance such collaboration. New businesses and technologies are something that is created through cross-organizational collaboration between partners that share the same set of values. Accordingly, we will continue to value the approach of improving ourselves and others through the establishment of solid partners.

### Pursuing Sustainability Management with “Zero” as Our Ultimate Goal

The DENSO Creed has been the starting point for DENSO since its founding. The ideals of our predecessors are encapsulated by the DENSO Creed, and we have inherited these ideals and continue to put them into practice today. Furthermore, we will ensure that these ideals will be passed on to the next generation. This entire process forms the basis of our sustainability management. The DENSO Creed includes the phrase “Provide quality products and services.” Our ambition to contribute to the fields of “green” and “peace of mind” for the sake of customers represents our commitment to this ideal.

In the field of “green,” worldwide trends are shifting from low-carbon to carbon-free with the aim of realizing a carbon neutral society. Amid these trends, we have extended our target of achieving a 50% reduction in CO<sub>2</sub> emissions to cover not only our production activities but also the products we offer. This means that we aim to become carbon neutral, or in other words, have the CO<sub>2</sub> we emit be offset by the CO<sub>2</sub> we absorb for net zero emissions.

## CEO MESSAGE

Additionally, in the field of “peace of mind,” we will remain fully committed to our goal of realizing a world with zero traffic accidents.

With “zero” as the ultimate goal in both the “green” and “peace of mind” fields, we will contribute to the creation of an even better society. This will certainly be no easy task, but the feasibility of reaching these targets is increasing due to recent technological innovations. More importantly, the act of setting such targets can actually bring about a major change in our awareness and ways of thinking when we work to resolve issues. This, in turn, can lead to the creation of new value. Going forward, while increasing our number of outside partners, we will work to steadily foster a corporate culture in which we come together as a company to consider and act on what we need to do to resolve social issues on our own initiative. As the leader of DENSO, I will be truly happy if we can become a company that is truly inspiring to society as a result of creating such a corporate culture.

### **Promoting a DENSO-Style Software-First Approach with *Monozukuri* and *Hitozukuri***

As part of our commitment to manufacturing, we implement the concept of *Monozukuri* (the art of making things) leads to *Hitozukuri* (human resource development). Our employees develop their skills through the pursuit of *Monozukuri*, and those skills are then passed on to the next generation. This process forms the basis of DENSO-style *Monozukuri*. *Monozukuri* not only refines the skills of our engineers and technicians, it also strengthens their spirit. In the hypothetical scenario where we completely change the kinds of goods we manufacture or where we enter fields outside of manufacturing, the ideal of strengthening employees’ skills and spirit through *Monozukuri* will still remain at the core of such activities. Across a variety of meanings, “goods” are something that brings happiness to people. This happiness represents the much deeper value of goods that transcends the physical dimension. For those that produce goods as well, supplying goods that support people’s lifestyles and meet their needs is something that can offer happiness which is one of a kind. By sharing this happiness through *Hitozukuri* and building a company with people as the foundation, I believe we can truly become a company that is useful to its customers and society as a whole. With the popularization of *Monozukuri* heavily focused on software going

forward, the skills that we need to possess will change. The kind of human resources we will need and the way we develop these human resources will also change. However, our desire to become a company that is useful to its customers and society will remain at the core of our activities.

DENSO has a reliable base of 170,000 employees that have been strengthened through *Monozukuri* in the fields of mechanics, electronics, and software. With the collective skills of these employees, I am confident that we can establish systems supported by the three pillars of mechanics, electronics, and software. I also firmly believe that these skills represent the source of our strengths as a company and will enable us to promote a DENSO-style software-first approach going forward.

### **Aiming to Realize a Mobility Society Led by the Passion and Smiles of People**

For the past 20 years or so, I have made “passion and smiles” my personal motto, and I value that motto in the management I pursue with the Company. Under the current unprecedented and uncertain state of affairs in which we are unable to forecast the situation going forward, passion will be what enables us to have the courage to push forward, and smiles will spread positive energy around the Company that will help ease the struggles we are facing and bring us happiness. As the leader of DENSO, I will aim to make our workplace environments places that are overflowing with passion and smiles.

When you step into a working environment where each employee can be passionate and enthusiastic and work with a smile, you gain a tremendous sense of dynamic energy and passion. Workplaces with dynamic energy and passion begin with a unique kind of spirit, “氣 (ki).” This spirit becomes the driving force that enables an organization to overcome adverse circumstances. Although this spirit is not something that can be visualized, its value to a company is extremely important.

Our current situation reminds me of my experience serving as the president of a subsidiary in Italy. To help this subsidiary recover from the massive losses it was dealing with, I focused my efforts first on engaging in open communication with those working under me. I held a total of 200 meetings with the approximately 2,000 employees at the subsidiary, speaking with groups of 10 employees at a time. At these meetings, I candidly communicated the current situation facing management and the direction we

were aiming for with our reforms. While, unfortunately, there were certain employees who could not empathize with my vision and decided to leave the company, the majority of employees ended up sharing the same ambitions I had. I communicated to these employees the gratitude I felt from the bottom of my heart and my intention to work closely together with them to rebuild the company. While many difficulties were in store for them on this path toward renewal, these employees gradually started to put their hearts and souls into achieving our goals, which gave rise to a new spirit that could be felt across the company.

What has worried me recently is that this unique spirit, “氣 (ki),” seems to have weakened internally. As a member of management, it is undoubtedly my duty to bring out the dynamic energy of each employee and enhance our level of passion as an organization. Right now, what DENSO needs is an environment where each employee can express their dreams; dreams that are uniquely their own, not something forced onto them by someone else. These dreams will differ from person to person, but by having employees share their dreams with each other, they can find areas where their dreams overlap, which in turn will give rise to something that is much greater. Through the process of clarifying the dreams of employees, which will grow bigger through the act of sharing, we can come to understand specific challenges. To a greater extent, this process will ultimately foster among employees a true sense of fulfillment, personal growth, and contribution to the Company.

During my time in Italy, I emphasized to the employees the idea of “respecting others, trusting each other, and working together.” Under our current situation, I am once again realizing the importance of those words. Our employees should take interest in each other and build relationships based on respect and trust. Through these relationships, employees can tackle challenges together. No matter how far digital innovations progress, ultimately it will be people who consider and make use of these innovations. While continuing to value the perspective that *Monozukuri* is *Hitozukuri*, we will contribute to the creation of a caring mobility society led by people. Furthermore, rather than promoting win-win relationships between people and corporations, which focus on winning and losing, we will strive to establish “happy-happy” relationships, which bring happiness to all people. By doing so, we will make every effort on a Companywide level to deliver a bright future where the blue sky spreads to the next generation.

I would like to ask our shareholders and other investors for their continued support as we pursue these endeavors going forward.

October 2020

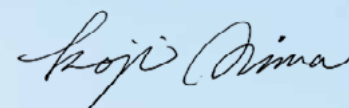

Koji Arima  
President & CEO



# Continuing to Create Value

## Past, Present, and Future



## Identity

### —What We Have Inherited Since Our Founding

Engraved in the DENSO Creed is the universal DENSO Spirit. In 1956, seven years after the Company's founding, we formulated the DENSO Creed to express in words the mentality of all DENSO employees—which we have had even before splitting from Toyota Motor Co., Ltd.—for taking the next step toward new progress based on a clear self-awareness. The DENSO Creed lays out four ideals that have served as the source of the Company's progress, and these ideals are still inherited today by our 170,000 employees across the globe. One of these ideals is "provide quality products and services." This ideal signifies DENSO's approach since its founding for

continuing to be a company that society needs by pursuing innovations in anticipation of the changing times and resolving social issues through quality products and services. In addition, this ideal serves as the basis to our approach to sustainability management, toward which we are currently accelerating efforts. As we enter into the period of a paradigm shift, all employees will reflect on the essence of the DENSO Creed in an effort to further refine the quality of all of our business activities. In this way, we will continue to create value that leads to the resolution of issues in the generation to come.

### History of Creating Value to Address Social Issues

#### 1950s

##### Taking on the challenge of resolving social issues using cutting-edge technologies from the time of our founding

- Developed and mass-produced electric cars to address global gasoline shortages
- Reinforced corporate foundation through technical cooperation with Robert Bosch GmbH and by successfully competing for the Deming Prize

#### 1960s

##### Efforts to address air pollution in advance of tightening emission regulations

- Succeeded in realizing the practical application of injection systems to respond to the worsening issue of air pollution ahead of the introduction of strict emission regulations
- Promptly established a system for the complete in-house production of integrated circuits (ICs) for automobiles

#### 1980s

##### Commercialization of safety systems for preventing traffic accidents

- Leveraged the research we have engaged in since the 1960s to realize the practical application of various safety systems, including anti-lock brake systems, airbag sensing systems, and forward collision warning systems

# for the Mobility Society



## Fundamentals

### —What We Have Cultivated in the 70 Years Since Our Founding

With the DENSO Spirit as the driving force, DENSO's innovations start from a focus on the future and what makes people happy. Our mission as a corporation is to anticipate changes in society and resolve social issues from the perspective of sustainability. Based on this mission, we have continued to realize growth while

consistently leading changes in the mobility domain and repeatedly pursuing innovations and new creations. Throughout this journey, we have cultivated strengths and capital that will continue to be the source of our value creation well into the future, thereby expanding our business domains.

- STORY 1** Cultivated Strengths □ P.20-21
- STORY 2** Our Accumulated Capitals □ P.22-23
- STORY 3** Creating New Value through Our Six Core Businesses □ P.24-25



### 1990s Contributions to eco-friendly lifestyles with core technologies

- Focused on the development of car air-conditioning systems that use natural refrigerant to curb the destruction of the ozone layer caused by conventional air-conditioning refrigerant
- Commercialized household heat pump water supply systems that contributed to energy savings. Also, developed water filters, QR codes, and other products that make people's lives more comfortable through the application of our core technologies

### 2000s Acceleration of business-wide CO<sub>2</sub> reduction initiatives to combat global warming

- Accelerated the development of eco-friendly products in all product fields
- Launched DENSO Eco Vision 2005 to share our environmental guidelines world-wide and accelerate initiatives for reducing CO<sub>2</sub> emissions from our business activities and realizing zero emissions

### 2010s Contributing to society by maximizing the value of "green" and "peace of mind"

- Commenced efforts toward sustainability management in 2018 to further clarify our contributions to resolving social issues in the automobile domain by providing value for "green" and "peace of mind"

STORY 1

# Cultivated Strengths

## The Greatest Strengths That Have Driven DENSO's Growth

Over its 70-year history, DENSO has cultivated various unique strengths. These strengths have been passed down since DENSO's founding and further refined through the Company's DNA, the DENSO Spirit, which permeates the actions of all DENSO employees around the world. The connections between these strengths have driven DENSO's growth over the years. Amid a challenging business environment going forward, DENSO will further enhance these strengths as the driving force behind value creation that is uniquely DENSO. In addition, DENSO will enhance the quality of its end products and services by refining the substance of these strengths, thereby creating new value.



# 01

## Research and Development

P.42-43

Through the accumulation of a long research and development (R&D) track record, which has supported our cutting-edge car manufacturing techniques, we are able to make full use of technologies that cover a broad range of fields, including chemistry, physics, electronic engineering, and software. This in turn enables us to create competitive products that will be useful in the future.

### The Key to Our Strengths

- ➔ Commitment to world-firsts
- ➔ Global Development Network
- ➔ Advanced research with a view to the future

### Further Enhancing Our Strengths

DENSO, which possesses knowledge on in-vehicle components, and Toyota Motor Corporation, which has knowledge on mobility and automobiles, jointly established MIRISE Technologies to pursue research and advanced development of next-generation in-vehicle semiconductors. By combining the knowledge of these two companies, MIRISE Technologies will contribute to the realization of a new mobility society that offers safety and comfort.

### Roots of Our Strengths

- 1953** Established a technological and production base through a technical cooperation agreement with Robert Bosch GmbH. With this base, we aimed to become a comprehensive manufacturer of automotive parts that can keep pace with global companies.
- 1971** Established Nippondenso of Los Angeles, Inc. The establishment of this company gave us an opportunity to significantly enhance the strengths of our technologies and products by expanding overseas ahead of car manufacturers.
- 1991** Established the Fundamental Research Center. At this center, we carried out R&D activities that covered a wide range of fields with a view toward creating technologies for five to 20 years in the future. Accordingly, this center served as a foothold for the various technological development activities we pursue today.
- 2014** Since 2008, we have been working to expand and enhance our technical centers around the world so that we can realize the development, manufacture, and supply of products optimized to each region. Through these efforts, we have successfully established technical centers in seven regions across the globe. In this way, we have set up a structure to create competitive products that can promptly meet diversifying local needs.

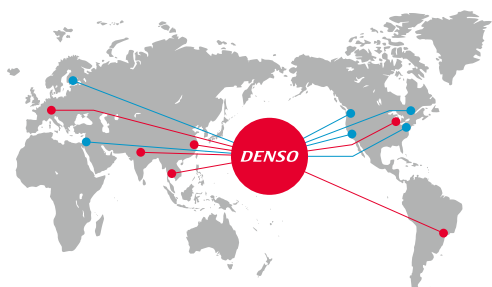



## Monozukuri

□ P.44-45

Through our *Monozukuri* capabilities that combine our technologies and techniques, we create innovative, world-first ideas one after the other. Through the high-level production technologies we possess, we create added value in the form of high efficiency and high quality. We also independently create technologies to respond to the need for accuracy and technologies that will be needed in the automobiles of the future. We are also involved in the soft domain, including the development of semiconductors.

### The Key to Our Strengths

- ➔ World-leading production engineering
- ➔ Factory-IoT that brings out the knowledge of people to the greatest extent possible
- ➔ Excellent factory (EF) activities that realize growth for both plants and people

### Further Enhancing Our Strengths

DENSO's Factory-IoT platform forms connections between its 130 factories around the globe to share data and know-how on making improvements. This platform, which combines in-house functions and open-sourcing, has been secured internally and can promptly respond to all kinds of changes and necessary improvements on the front lines of production. With its high level of expandability, this system also helps accelerate on-site improvements and productivity enhancements.

### Roots of Our Strengths

- 1968 Created the IC Research Center in anticipation of the shift to the electronic control of automotive parts in the future. This laboratory provided us with a structure for the production of IC technologies completely in-house.
- 1972 Gradually established overseas production companies. These companies helped us gain an understanding of the needs in each region and begin production activities that met those needs.
- 1979 Received the Okochi Memorial Production Prize. This prize was received in recognition of our highly accurate, high-quality product creation that was realized through our comprehensive in-house manufacturing of production lines and equipment.



## Hitozukuri

□ P.46-47

Based on the idea that "the best products are made by the best human resources," we have cultivated personnel who can tackle the issues they face and create new technologies and products without fearing change. By instilling the DENSO Spirit, our DNA, on a Companywide basis, we continue to develop personnel who can create world-leading, cutting-edge products.

### The Key to Our Strengths

- ➔ DENSO Spirit
- ➔ Global human resource development
- ➔ Cultivation of young technicians

### Further Enhancing Our Strengths

At DENSO, we have promoted the creation of working environments and systems in which all employees can play an active role, regardless of age, gender, or nationality. We have also introduced new systems geared toward senior-level employees, the number of whom will likely increase going forward, to help them enthusiastically display their individuality and leverage their skills and techniques in the fundamental areas of production, quality, and *Hitozukuri*.

### Roots of Our Strengths

- 1954 Established the Technical Training Center. This center fostered the principles of "*Monozukuri is Hitozukuri* (our performance relies on our people)" and "engineering and technique go hand in hand." These principles are still practiced by the Company today.
- 1961 Received the Deming Prize, the most prestigious award for quality control. The efforts made by all employees to win this prize laid the foundations for the concept of "Quality First," and also helped us establish a corporate culture that fosters trust.
- 1977 Received our first gold medal in the WorldSkills Competition. Receiving this medal was the result of our skills training in which we have invested resources since our founding. Since then, DENSO has earned more than 60 WorldSkills medals.
- 2005 Established the DENSO Training Academy, our first overseas regional training center. This center helped us build a structure for educating engineers and technicians on a global basis.

STORY 2

# Our Accumulated Capitals

## Capitals Supporting Our Global No. 2 Position in the Industry

DENSO has grown its revenue to ¥5.2 trillion, securing the No. 2 position globally in the automotive parts industry. Now, DENSO's products are installed in cars all over the globe. The capitals that we have accumulated while achieving this growth now support the scale of our business activities and provide us with the funds needed to enhance our corporate value. We are working to refine the substance of the strengths that drive our growth in an effort to boost our overall quality. By doing so, we will reinforce our human, manufacturing, intellectual, and social and relationship capitals, which in turn will help us increase our financial capital. To realize sustainable growth while accelerating this kind of cycle, we will maintain and enhance these capitals going forward.



### Financial Capital

P.48-53

To realize sustainable growth and further improve corporate value, there is a need to secure continuous funding for capital expenditures and investment in R&D activities, alliances, and M&A. DENSO generates over ¥1 trillion in cash every year through its business activities (including operating cash flow plus other cash generation activities). Going forward, we will realize further business growth by using this cash to make effective investments.

#### Cash generation capabilities (operating cash flow)

¥395.5 billion → **¥595.3 billion**  
Fiscal 2011 Fiscal 2020



### Human Capital

P.54-55

DENSO operates businesses in over 30 countries and regions around the world. Accordingly, DENSO is a company that draws on the personalities and ideas of its diverse group of human resources—who are of different genders, ages, and nationalities and lead different lifestyles—in order to constantly evolve. To that end, we are promoting an active role for all employees and striving to establish a corporate culture where each employee can continue to work in good physical and mental health.

#### Ratio of overseas employees

48% → **55%**  
Fiscal 2011 Fiscal 2020







## Manufacturing Capital

P.56-57

Amid the expansion of the soft domain and the rapid emergence of newcomers in the automotive industry, we believe that the ability to globally provide high-quality, highly reliable products that can be installed in vehicles—something in which people entrust their lives—is a crucial element in achieving differentiation. Drawing on the car manufacturing insight we have cultivated in the 70 years since our establishment, we are taking the initiative to evolve our facilities by introducing the latest technologies while refining our technological and business execution capabilities for the real world.

### Capital expenditures

¥145.1 billion → **¥436.5 billion**

Fiscal 2011

Fiscal 2020



## Intellectual Capital

P.58

We find ourselves in the midst of a paradigm shift in which new technologies are being created at a tremendous speed, and the nature of business itself is changing. In this environment, R&D capabilities are becoming even more important. DENSO considers R&D expenditure at around 9% of revenue to be an appropriate level. Based on this level, we are expanding our developmental domains and accelerating the speed of our development activities. At the same time, we are improving investment efficiency through the introduction of cutting-edge technologies, such as standardization activities and evaluations via simulators, as we work to patent our developmental assets.

### R&D expenses

¥290.1 billion → **¥507.8 billion**

Fiscal 2011

Fiscal 2020



## Social and Relationship Capital

P.59-60

In the paradigm shift, which occurs once every 100 years, we need to respond to the needs of society with a sense of speed and further invigorate our business activities. This is a task that we cannot do on our own, and it is therefore necessary to collaborate with our various stakeholders. To that end, we are constantly holding dialogues with our stakeholders to convey to them our dreams and aspirations in an effort to find partners who share the same aspirations as we do and will work together with us to achieve mutual growth. In these ways, we strive to become a company that is truly inspiring to society.

### Number of supplier companies

Approx. **5,000** companies → **Approx. 6,100** companies

Fiscal 2011

Fiscal 2020



STORY 3

# Creating New Value through Our Six Core Businesses

Pursuing a Variety of Businesses That Will Support the Mobility Society of the Future

DENSO was established as a manufacturer of electrical equipment and radiators. Since its establishment, the Company has expanded its business domains in conjunction with social change, applying the technologies it has cultivated in the automotive field, its main area of operation, to develop lifestyle and industrial-related equipment. At the moment, DENSO has six core businesses that devise solutions for the mobility society of the future. Centered on these core businesses, DENSO is making full use of the technologies it has accumulated in the automotive domain as it pursues a variety of businesses that support the mobility society of the future.

## Six Core Businesses

### Main Products

### Thermal Systems

P.64-65

Providing safe, comfortable systems that use the least amount of energy possible in consideration of the environment



HVAC units



Condensers

### Powertrain Systems

P.66-67

Providing solutions that help overcome the seemingly contradictory task of balancing the joy of life with vehicles with superior environmental performance



Gasoline direct injector



High pressure pump

### Electrification Systems

P.68-69

Supporting electrification in all areas of mobility to realize an enriched environment and the joy of driving



Motor generator



Power control unit

### Mobility Electronics

P.70-71

Realizing a society in which all people can move comfortably and with peace of mind (Quality of Mobility)



Vision sensors



Millimeter-wave radar sensors

### Sensors & Semiconductors

P.72-73

Leading the industry in semiconductor and sensing technologies that are eco-friendly and help realize a mobility society with comfort and peace of mind

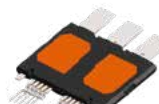

Power cards



Wheel speed sensors

### Non-Automotive Businesses (FA and Agriculture)

P.74-77

Enhancing the productivity of the manufacturing industry and contributing to an improved quality of life with a commitment to our long-cultivated technologies (factory automation [FA])

Combining technologies and ideas to contribute to an enriched society where all people can live safely and with peace of mind (Agriculture)



Vertical articulated robots



Environmental control systems for greenhouse cultivation, Profarm-Controller

Areas to which our six core businesses contribute

## The Four Focus Fields of Our Six Core Businesses

### Electrification

**Providing Value**

#### Reducing Environmental Burden and Realizing Highly Efficient Mobility

DENSO has been engaged in the development of electrified vehicle systems that are eco-friendly and enable even more comfortable travel. As a result, DENSO has realized high-functioning, compact, and fuel-efficient products that are essential for hybrid vehicles and is producing these products around the world. Going forward, we will leverage our expansive business domains to form linkages between various in-vehicle systems and products in an effort to efficiently manage energy within vehicles. In this manner, we will further improve fuel efficiency and contribute to the conservation of energy.



### Advanced Safety and Automated Driving

**Providing Value**

#### Realizing a Safe Society without Accidents, and Free and Comfortable Mobility

DENSO aims to create a mobility society without accidents and in which all people can move safely and with peace of mind. Guided by this aim, DENSO has developed reliable, high-quality safety technologies. By enhancing our long-cultivated sensing technologies as well as our AI and information technologies, we will further contribute to the development of automated driving. Maintaining our firm commitment to quality, which we have adopted since our founding, we will deliver genuine peace of mind for the future of the mobility society.



### Connected Cars

**Providing Value**

#### Realizing a New Mobility Society That Connects Vehicles, People, and Goods

Amid the major transition from the trend of owning a vehicle to the trend of using a vehicle as a service, DENSO is pursuing efforts in the Mobility-as-a-Service (MaaS) business, which involves providing mobility services that move people and goods. Going forward, we aim to provide safe, secure, and efficient transportation methods with low environmental burden for people with vehicles and for those without, thereby contributing to the realization of a new mobility society.



### Non-Automotive Businesses (FA and Agriculture)

**Providing Value**

#### Contributing to Improved Social and Industrial Productivity

DENSO has a solid track record of introducing factory automation (FA) systems in 130 factories. Leveraging this record, we will propose and provide FA systems that can meet the diverse needs of our customers, thereby making extensive contributions to the development of the manufacturing industry. Also, with the aim of delivering happiness to all people through agriculture, we will draw on the expertise and know-how we have cultivated in the automotive field to offer new value in agricultural fields.



Providing new value to the mobility society

**DENSO's Value Creation Process**

# Maximizing the Value of "Green" and "Peace of Mind" to Continue to Grow with Society

To fulfill the DENSO Philosophy, we are incorporating social issues into our Long-term Vision and into our material issues (Materiality) and are implementing sustainability management that works to resolve social issues through our business activities. By doing so, we will contribute to a sustainable society and improve our corporate value.

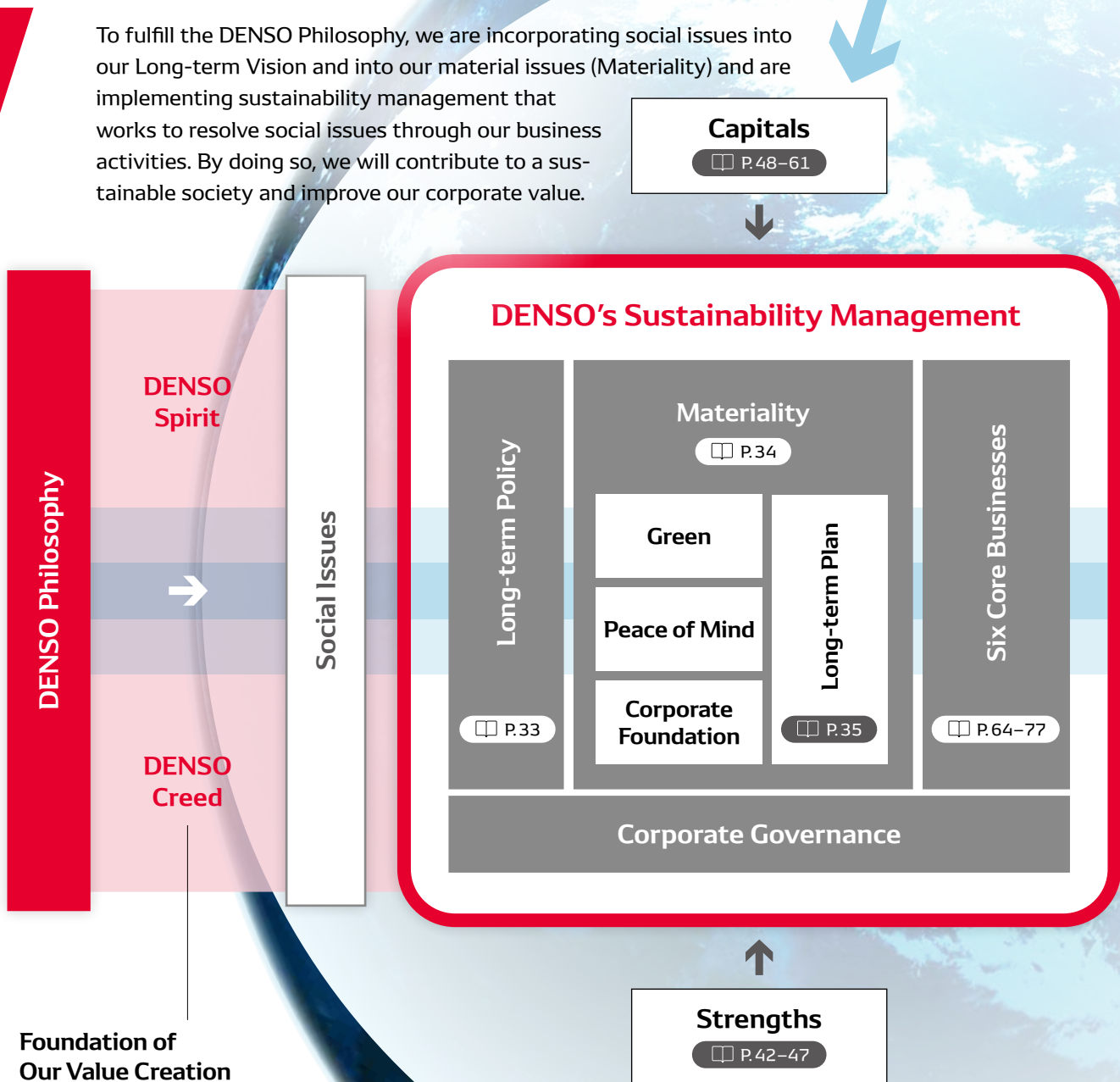

**Foundation of Our Value Creation**

The DENSO Creed, which embodies the spirit of our founding, and the DENSO Spirit, which serves as an action guideline, form the foundation of our value creation. Each and every employee respects the DENSO Creed and DENSO Spirit and works to earnestly reflect them in their actions. This, in turn, helps invigorate the value creation process.

## Reinforcement

### Progress in our four focus fields

Electrification

Advanced Safety and Automated Driving

Connected Cars

Non-Automotive Businesses  
(FA and Agriculture)

### Value we offer society

- ➔ Reduction in the amount of energy used by our products
- ➔ Reduction in CO<sub>2</sub> emissions from our products
- ➔ Ratio of in-house power generation through cogeneration systems\*<sup>1</sup> within energy consumed in our business activities: 46% (non-consolidated)
- ➔ CO<sub>2</sub> emissions per unit\*<sup>2</sup> related to our production activities (compared with fiscal 2013): 63% (non-consolidated), 60% (Group companies)
- ➔ MSCI ESG rating: A

Green

Inspiring

Peace of Mind

### Realizing a Sustainable Society

Contributing to the SDGs through our corporate activities



- ➔ Prevention of traffic accidents through our products
- ➔ Realization of comfortable and open vehicle interiors through our products
- ➔ Guarantee of safety through our rigorous quality control activities
- ➔ Decrease in accidents related to our business activities (compared with target for 100% elimination): 51% reduction on a global basis

\*<sup>1</sup> Energy-saving systems that can generate electricity and make use of waste heat using city gas, which gives off only a small amount of CO<sub>2</sub>

\*<sup>2</sup> Per unit = CO<sub>2</sub> emissions/Revenue Limited to CO<sub>2</sub> emissions from energy sources (Figures for each capital and value provided are based on fiscal 2020 results.)

# 1 Growth Strategy

- 29 Awareness of Business Environment
- 32 Outline of Management Policies
- 33 **1** Long-term Policy
- 34 **2** Materiality
- 35 **3** Long-term Plan
- 36 Mid-term Plan and DENSO Revolution Plan "Reborn21"
- 38 Efforts to Maximize the Value of "Green"



## Awareness of Business Environment

Amid global population increases, aging societies, and advancing urbanization, the progression of global warming due to CO<sub>2</sub> emissions and the increase in traffic accidents are becoming serious social issues. In addition, business models are changing and people's value systems and consumption behavior are diversifying due to the rapid digitization of society and advancements in robotics. Amid these circumstances, we have recently been experiencing massive change in our daily lives due to the COVID-19 pandemic. These changes have included the practice of social distancing and restrictions on transportation. As a result, social issues and value systems are becoming increasingly more complex and diversified.

In the mobility domain, the evolution of electrification, automated driving, and connected cars due to the progression of IoT and AI has been remarkable. At the same time, a significant number of issues have been emerging. Going forward, we will continue to pursue the resolution of social issues while accurately assessing and responding to risks and opportunities related to these various social changes.

### Social Changes as of 2030

Making use of PEST (political, economic, social, and technological) analysis, we have narrowed down our forecasts of future society using social changes as of 2030 as a key theme. On the following page, we explain our analysis of the changes in the automotive society based on this key theme, and identify risks, opportunities, and major issues for DENSO moving forward.

#### Forecasts of Future Society

##### Politics

- Necessity of renewable energy and hydrogen storage in realizing a low-carbon society ..... 1
- Acceleration of international cooperation to respond to climate change in light of the urgent need to address global warming ..... 1
- Corporate strategies with an awareness of social and environmental burden throughout the entire supply chain ..... 1 2
- Trade conflict between the United States and China ..... 4
- Shift from low carbon to carbon free ..... 1
- Diversification of energy sources by region, expanding demand for natural gas in the Middle East and China ..... 4
- Tightening supply and demand of energy due to increased demand from emerging countries ..... 1

##### Economy

- Rise of emerging countries and global multi-polarization ..... 3 4
- Deepening and expansion of economic collaboration, shift to borderless capital transactions ..... 2 3
- Obstructions to the borderless trend due to increasing disparity gaps and the rise of protectionism ..... 2 3

##### Society

- Threat to the sustainability of society due to the rapid increase in population, with the global population exceeding 8 billion ..... 1 2
- Aging populations around the world, declining workforce, acceleration of growth in life expectancies ..... 3
- Urbanization in emerging countries, acceleration of urban regeneration due to the shift to smart and compact devices ..... 3
- Consumption behavior becoming more ethical and experience-based with the shift to the sharing economy ..... 1 2
- Progression in the transition to labor offered by AI and robotics, changes in work ethic and available free time ..... 1
- Change in value systems related to social distancing and mobility ..... 2

##### Technology

- Integration of digital and physical domains due to the progression of IoT and wearable devices ..... 2
- Productivity enhancement and value chain integration through the use of big data ..... 2
- Transition to the phase of AI utilization and the versatile implementation of AI in manufacturing, finance, and services ..... 2

#### Keywords for Social Changes by 2030

##### 1 Shift toward a recycling-oriented, low-carbon society

Changes in the powertrain mix (electrified vehicles, internal combustion engine vehicles)

##### 2 Diversification of people's values and consumption behavior

Diversifying consumption behavior and value systems  
Evolution of IT communications × Automobiles

##### 3 Emergence of social issues

Aging population, depopulation, overcrowding, and congestion

##### 4 Shift of power to emerging countries

Market diversification

#### Awareness of Climate Change Initiatives toward the TCFD: □□ P.38-40

Concern over climate change is rising around the world in light of rising temperatures, the increase in natural disasters, and other weather-related phenomena. The automotive industry has a particularly high impact on the environment, and it is essential to strengthen efforts to reduce CO<sub>2</sub> emissions if we wish to realize a sustainable society. In light of these circumstances, we formulated DENSO Eco Vision 2025. Under this latest Eco Vision, we are promoting efforts to reduce CO<sub>2</sub> emissions not just from the products we develop but also within our entire corporate activities in all regions where we operate. Additionally, we recognize that exhaust gas regulations, which continue to tighten, present us with both a risk and an opportunity for growth going forward.

## Major Issues for DENSO Based on Risks and Opportunities

Based on future forecasts which we have narrowed down on the previous page using social changes as of 2030 as a key theme, we have analyzed risks and opportunities and identified major issues for DENSO based on this analysis. We will continue to pay close attention to the impact of the COVID-19 pandemic and thoroughly examine whether or not the pandemic will have an impact on the major issues for DENSO going forward. While doing so, we will work to gain an accurate understanding of the outlook for the CASE revolution and changes in the automotive society.

### Risks and Opportunities

### Response Measures to Risks and Opportunities

#### 1 Shift toward a recycling-oriented, low-carbon society

- Risks**
- Tightening environmental regulations on the automotive industry
  - Advancing the introduction and expansion of environmental taxation by the governments in each country and region
  - Increasing trend in establishing limitations on GHG emissions

- Opportunities**
- Growing need for electrification systems
  - Further increase in need for improving fuel efficiency

Regarding the risk of climate change, we believe there will be greater opportunities for us to popularize our long-cultivated technologies for fuel efficiency, low exhaust gas, and electrification around the world. Through flexible cooperation and competition with other companies, we aim to accelerate the development of technologies for reducing CO<sub>2</sub> emissions and realize the stable supply of such technologies on a global scale. Additionally, we will strive to curtail CO<sub>2</sub> emissions from our business activities, including in our manufacturing activities and across our supply chain.

#### 2 Diversification of people's values and consumption behavior

- Risks**
- Reduction in transportation as the customs in the new normal era become commonplace
  - Intensifying competition due to the increasing entry of IT companies in the automotive industry in response to the digitization of cars

- Opportunities**
- Heightened awareness of "peace of mind," leading to the diversification of technologies related to "peace of mind" and expansion in value systems (social distancing, privacy, disaster alerts, etc.)
  - Rising need for added value due to the accelerating shift to digital technologies and IT
  - Growing awareness of eco-friendly products

By swiftly responding to diversifying needs such as automated driving and the provision of safe and comfortable vehicle interiors, we can increase the number of growth opportunities for DENSO. To respond to the risk of companies from other industries entering the automotive industry, we are collaborating with other companies both inside and outside the automotive industry to leverage our respective fields of expertise while also strengthening our unique technological and manufacturing capabilities. By doing so, we will invigorate our development activities in new domains with a sense of speed.

#### 3 Emergence of social issues

- Risks**
- Trend in turning away from automobiles due to the impact of social issues (increase in traffic accidents due to the declining birthrate and aging population, air pollution, worsening traffic congestion resulting from urbanization, etc.)

- Opportunities**
- Expansion of businesses that contribute to the resolution of social issues (growing needs for automated driving, the prevention of traffic accidents, food safety, electrification to address labor shortages, etc.)

Alongside the commercialization of products such as household appliances and automobiles, social issues such as the aging population, depopulation of rural areas, overcrowding of urban areas, and traffic congestion have become more severe. To resolve these issues, we will strive to constantly develop technologies and create businesses that help keep people safe and work to expand these technologies and businesses across the globe.

#### 4 Shift of power to emerging countries

- Risks**
- Diversification of business practices due to globalization (excess in the number of business models that cater only to specific regions)
  - Increased competition due to the entry of manufacturers from emerging countries

- Opportunities**
- Further market and business expansion due to the growth of emerging and developing countries (particularly the growing demand for eco-friendly products and systems)

Growth in the automotive market will shift toward emerging countries such as China and India. This presents us with an opportunity to incorporate new growth. However, rather than simply applying the business practices we have adopted in developed countries, we will make proposals that meet the specific needs of each region while leveraging the global network that we have built up over many years.



### Developing Areas in the Automotive Society



### Major Issues for DENSO

## Maximizing the Value of “Green” and “Peace of Mind” to Be Inspiring

The developing areas in the automotive society present a significant opportunity for a company such as DENSO, which has continued to refine technologies and gain experience in the mobility domain. With the aim of reducing our environmental burden and realizing a society without traffic accidents, we will actively promote the creation of a mobility society with a view to achieving the goals of “lasting vitality for the environment” and “safe, comfortable and flexible mobility for all people.” Furthermore, we will continue to create new value that inspires society.

Long-term Policy: □□ P.33



### Reinforcing Both Hard and Soft Domains

Traditionally, the automotive industry has focused on the hard domain, which comprises the basic vehicle functions of running, turning, and stopping. However, based on the kind of social changes described on the left, there has been a growing need for added value provided through the soft domain, which leverages IT technologies, as well as domains that combine the hard and soft domains. By leveraging the hard domain, where we have existing strengths, and enhancing our competitiveness in the soft domain, we will capitalize on the growth opportunities mentioned on the left.

Reinforcing Our Strengths: □□ P.42-47

### Social Issues We Aim to Resolve

#### Main Targets to Be Achieved through Corporate Activities



# Outline of Management Policies

The DENSO Philosophy provides the foundation for drawing the outline of the Company's management policies, and sustainability management acts as the core for implementing these policies. In light of the aforementioned changes in the business environment and risks and opportunities, DENSO has formulated its Long-term Policy, which focuses on 2030. The Company also established material issues (Materiality) and its Long-term Plan as a path for realizing its Long-term Policy. Through these efforts, DENSO is implementing sustainability management. Please see the relevant pages for details on DENSO's Long-term Policy, Materiality, and business strategies.

## DENSO Philosophy

**Contributing to a better world by creating value together  
with a vision for the future**

## Sustainability Management

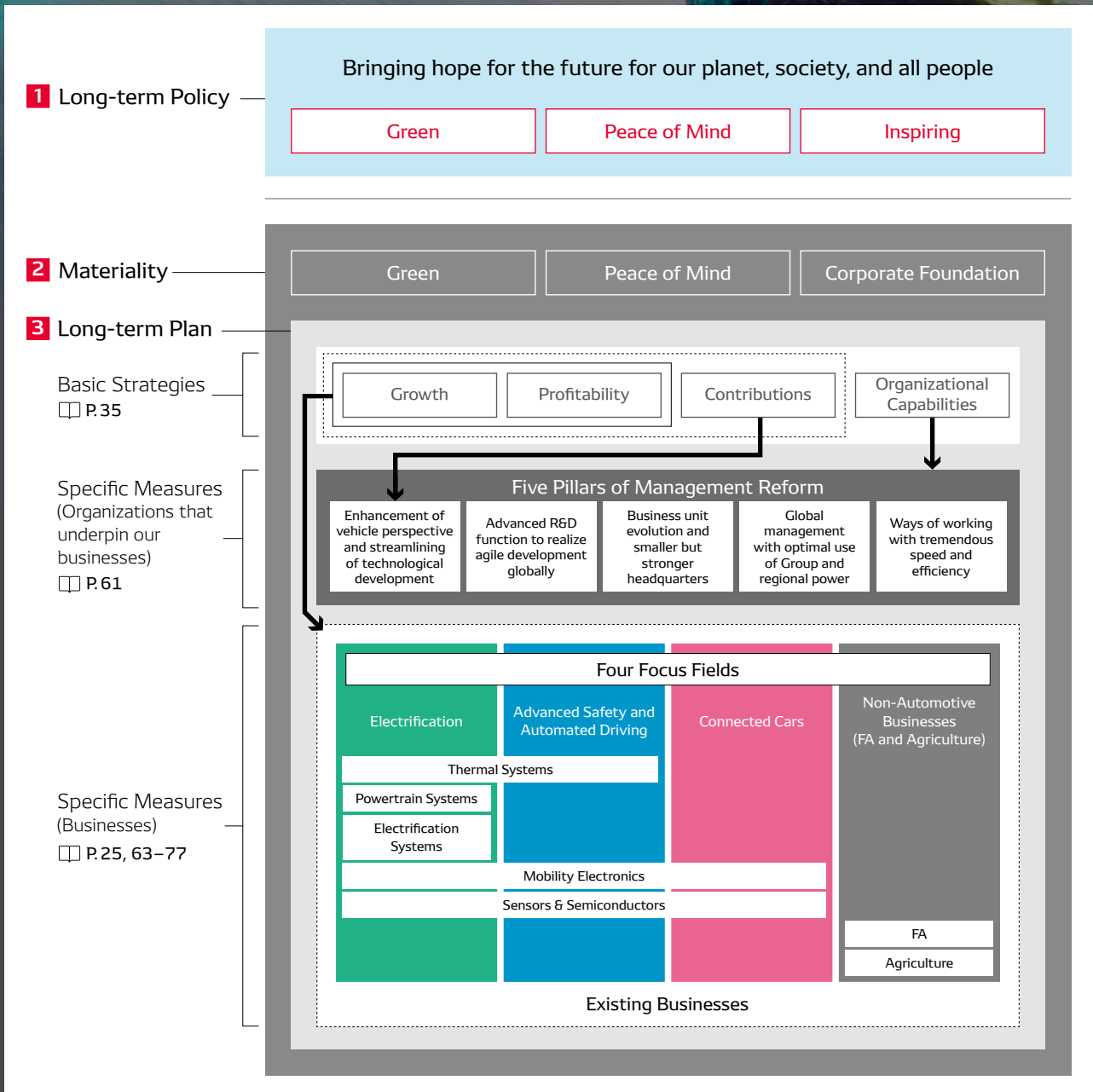

# 1 Long-term Policy

DENSO has formulated the Long-term Policy, which serves as a vision for what the Company aims to be by 2030. In addition to maximizing the value we provide through “green” and “peace of mind,” two of our conventional areas of focus, we have adopted the new theme of “inspiring.” Guided by these three themes, we will strive to gain the understanding of our diverse stakeholders regarding the various efforts we pursue. By combining the strengths we possess under each theme, we will generate new value for society.

## Slogan

Bringing hope for the future for our planet, society, and all people

## Our Goal for 2030

A company that continuously generates value to enrich mobility that achieves sustainability, happiness, and peace of mind for everyone

## Green

### Lasting vitality for the environment

Contribute to sustainability by increasing efficiency and reducing environmental impact

## Peace of Mind

### Providing a sense of well-being

Contribute to future mobility that is safer, more comfortable, and convenient for everyone

## Inspiring

### Making a difference

Contribute to happiness for everyone through inspiring value-added offerings

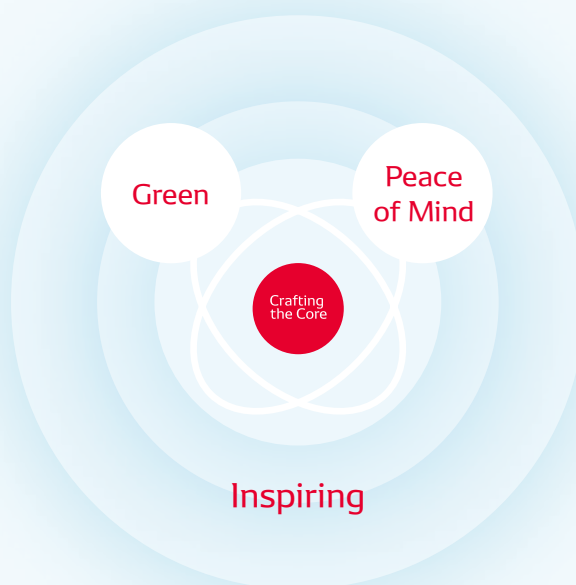

## Growth Indicators to Realize the Long-term Policy and Social Issues We Aim to Resolve

To realize its Long-term Policy, DENSO is working to achieve growth in its top line by realizing growth in new mobility domains and promoting management reforms, among other efforts. However, with the increased level of uncertainty regarding the outlook for consumption demand, and based on the fact that our highest priority issue recently has been shifting our focus from quantity to quality, we are now placing the most emphasis on profitability as an indicator for growth and aim to achieve an operating margin of 10% by fiscal 2026.

Furthermore, we have made connections between the social issues we aim to resolve through our business activities and the Sustainable Development Goals (SDGs), and have clarified the goals we aim to achieve on a Companywide level. At the same time, our employees have determined individual social issues that they can help resolve through their job and are working on a daily basis to do so.

## Growth Indicators (Fiscal 2026)

Operating margin **10%**

CFO Message: □ P.50–53

## Social Issues We Aim to Resolve

### Main targets to be achieved using our products and services



Materiality: □ P.34

## 2 Materiality

To enhance the transparency of our sustainability management and accelerate relevant initiatives, we have determined material issues (Materiality) and are making efforts to resolve these issues. Among the various social issues that are present today, including those highlighted in the SDGs, we determined that the three themes of “green,” “peace of mind,” and “corporate foundation” represent areas that have a high level of importance for realizing a sustainable society and areas in which we can make particularly significant contributions. Accordingly, we are sharing information on the material issues we have identified in each of these fields on a Companywide basis. We have established a specific vision and KPIs (numerical indicators, or guides) related to each material issue we have identified. By working to achieve these KPIs through our business activities, we will strive to resolve social issues going forward.

	Materiality	Vision	Related SDGs
Green	<ul style="list-style-type: none"> <li>Prevention of global warming </li> <li>Prevention of air pollution / Reduction of environmental burden </li> <li>Effective utilization of resources </li> <li>Conservation of water resources</li> </ul>	<p>Contribute to an eco-friendly and sustainable society by reducing environmental burden and realizing highly efficient mobility</p> <ul style="list-style-type: none"> <li>Provide technologies to prevent global warming and solve issues related to energy and resources, thereby contributing to the sustainability of the global environment</li> <li>Continue to be a company that grows together with society by pursuing continuous improvements in society as well as complying with laws and regulations</li> <li>Contribute to a society that shares the wisdom and blessings of nature through corporate activities that aim for a peaceful coexistence with nature</li> </ul>	
		<p>We have formulated the Eco Vision to serve as a long-term environmental policy to help us promote our environmental management.</p> <p> Please see the Sustainability section of our corporate website for more information on the Eco Vision. <a href="https://www.denso.com/global/en/about-us/sustainability/environment/ecovision/">https://www.denso.com/global/en/about-us/sustainability/environment/ecovision/</a></p>	
Peace of Mind	<ul style="list-style-type: none"> <li>Reduction of traffic accidents </li> <li>Provision of flexible and comfortable movement </li> <li>Provision of safe and secure products </li> <li>Response to decrease in birthrate and aging population </li> </ul>	<ul style="list-style-type: none"> <li>Contribute to a society where people can have peace of mind by eliminating traffic accidents and providing flexible and comfortable movement for all</li> <li>Provide safe and secure products that are of high quality to gain the trust and satisfaction of our customers</li> </ul>	
Corporate Foundation	<ul style="list-style-type: none"> <li>Compliance </li> <li>Information security </li> </ul>	<ul style="list-style-type: none"> <li>Ensure that each employee acts in a fair, honest, and ethical manner while complying with laws and regulations in each country and region</li> <li>Provide safe and reliable products to customers, protect information assets, and prepare for cyber security risks that the “connected society” faces</li> </ul>	
	<ul style="list-style-type: none"> <li>Diversity and inclusion</li> <li>Healthy and safe working environment</li> <li>Workstyle reform</li> <li>Protection of human rights</li> <li>Sustainable procurement</li> <li>Corporate governance</li> </ul>	<ul style="list-style-type: none"> <li>Promote the development of <i>people, organizations, and the working environment</i> to encourage our employees to maximize their abilities and work with enthusiasm and peace of mind</li> <li>Respect the human rights of all our stakeholders, including our employees and people throughout our supply chain, in our business activities</li> <li>Pursue business activities that take into account environmental issues, human rights issues, and compliance together with our suppliers</li> </ul>	

Targets that can be achieved using our products and services

SDGs for which our products and services can contribute to their accomplishment  
→ 3, 7, 9, 11, 12, and 13

### 3 Long-term Plan

DENSO has established its Long-term Plan for fiscal 2026, which acts as a pathway for realizing its Long-term Policy. Centered on the Basic Strategies shown below, DENSO has established four focus fields based on social changes. In addition to these fields, DENSO has adopted the Five Pillars of Management Reform (□ P.61) to enhance organizational capabilities and reflect its ambition to transition to an organization that can compete even under a challenging business environment. By promoting these reforms, DENSO will contribute to the realization of a sustainable society and enhance its corporate value.

#### Basic Strategies

**Growth**

By pursuing value from the perspective of the vehicle, we will accelerate the commercialization of new mobility fields, thereby driving **growth**.

New customers and value creation } Driving new growth	} Accelerating growth	Electrification	Advanced Safety / Automated Driving	Connected Cars

**Profitability**

We will enhance the **profitability** of our existing in-vehicle technology business and further solidify our earnings base to support future growth.

Pursuit of value through subsystems + Strong components } Improving profitability	Thermal Management Subsystems	Energy Management Subsystems	Information Management Subsystems
	Components	Components	Components

**Contributions**

To realize overwhelming levels of competitiveness for our components and systems, we are streamlining technological development related to ECUs, semiconductors, sensors, and motors. We are also improving the profitability of our existing businesses and strengthening our competitiveness in new mobility fields. Through such efforts, we will make **contributions** to meeting the needs of our customers.

Refining competitiveness by streamlining technology } Contributions to meeting the needs of our customers	ECUs	Semiconductors	Sensors	Motors

**Organizational Capabilities**

To realize the above initiatives, we will draw on our management reforms to accelerate the speed of business execution, invigorate the workplace, and strengthen our **organizational capabilities**.

Accelerating our business execution and invigorating the workplace as we transition to an organization that can compete in an era of rapid changes

# Mid-term Plan and DENSO Revolution Plan “Reborn21”

To make steady progress toward achieving our Long-term Plan, we have formulated specific action plans from the perspective of “taking on the challenge of creating new value,” “strengthening profitability to support future growth,” and “reforming our management foundation.” These action plans serve as a guideline for our efforts up to fiscal 2022.

In fiscal 2020, the business environment that surrounds DENSO underwent dramatic changes. These included the occurrence of a quality-related issue, which shook the foundation of our management, and the impact of the COVID-19 pandemic, which put a halt to our soaring growth in revenue. In light of these changes, restoring our quality, which is the foundation of our business and trust, as well as transitioning to a firm and robust corporate structure, which will allow us to respond to changes in the external environment in any age and provide new value, have become urgent issues for us. Accordingly, we began discussions on the DENSO Revolution Plan “Reborn21,” which will be implemented alongside the Mid-term Plan. We will accomplish the goals of both plans by fiscal 2022, making a new start for ourselves as a company with even higher added value.

## Mid-term Plan

### 1 Creating New Kinds of Value

- (1) Broaden our range of collaborations in integrated vehicle platforms that straddle product sectors to help assert leadership in electrification and in automated driving
- (2) Create and deploy business models for generating new value in mobility services and dramatically improving convenience
- (3) Position factory automation and agriculture as pillars of new business development and employ bold concepts to assert a strong presence in those sectors
- (4) Connect with brilliant minds at the centers of innovation worldwide to increase our agility in nurturing a continuing stream of new products
- (5) Build on the wisdom that resides in the Toyota Group to overcome the unprecedented change that is transforming the automobile industry and generate benefits for customers and society worldwide

#### Progress of Strategies

We have consolidated the electronic component business of Toyota Motor Corporation within DENSO. We have also jointly established a new company with Toyota that will conduct R&D activities on next-generation in-vehicle semi-conductors. In these ways, we have been promoting cross-organizational promotion with partners with which we share the same values. However, we have also faced issues in realizing new services and business models.

### 2 Strengthening Profitability in Support of Future Growth

- (1) Upgrade our interregional interaction and increase our management agility by reworking our organization to realize a smaller but stronger headquarters and performance-oriented business units and subsidiaries
- (2) Advance the performance of key products, such as motors, ECUs, semiconductor devices, and sensors, with leading-edge technologies, and reinforce the basis of our competitiveness through a commitment to asserting key product standards
- (3) Anticipate customer expectations in both growing and changing markets and address those needs through new projects undertaken with optimal partners
- (4) In our core product sectors, generate unprecedented workplace performance by pressing ahead with measures for achieving further advances in *DANTOTSU* (“best by far”) plants and for evolving our plants through the Factory-Internet of Things (F-IoT)
- (5) Accelerate product development and achieve high profitability by working independently and with partners to revolutionize development processes

#### Progress of Strategies

Although we have worked to enhance our R&D and production activities, which underpin profits, we currently have a corporate structure in which we would record losses if revenue declines by 20%. Taking into account the fact that we will soon see the end to an era in which we enjoyed soaring revenue growth, we must now transition to a firm and robust corporate structure.

### 3 Transforming Our Business Foundation

- (1) Exercise our shared awareness of working fundamentals, accumulated over the 70 years since DENSO's establishment, to address social expectations and earn customers' trust
- (2) Honor the spirit of the DENSO Creed in laying a foundation of uncompromising safety and quality that will support peace of mind for customers in traditional sectors and in new sectors, such as intelligence- and information-based functions
- (3) Tap the full potential of each team member and maximize our workplace vitality and our responsiveness to challenges and opportunities by nurturing a motivational workplace and by making the most of advanced information technology
- (4) Improve our responsiveness to fluctuations in demand by accelerating our Excellent Factory (EF) activities, and shape a lean production system throughout our supply chain
- (5) Do our part to address expectations in the international community for meeting the SDGs, and undertake sustainability management with an eye to generating both economic value and social value

#### Progress of Strategies

We have been making progress with a broad range of initiatives, including promoting activities to spread awareness of the SDGs and sustainability management in accordance with the characteristics and issues in each region as well as establishing new workstyles through the utilization of IT. However, due to the occurrence of our largest-ever quality-related issue, we are faced with the urgent task of restoring our foundation as a company.

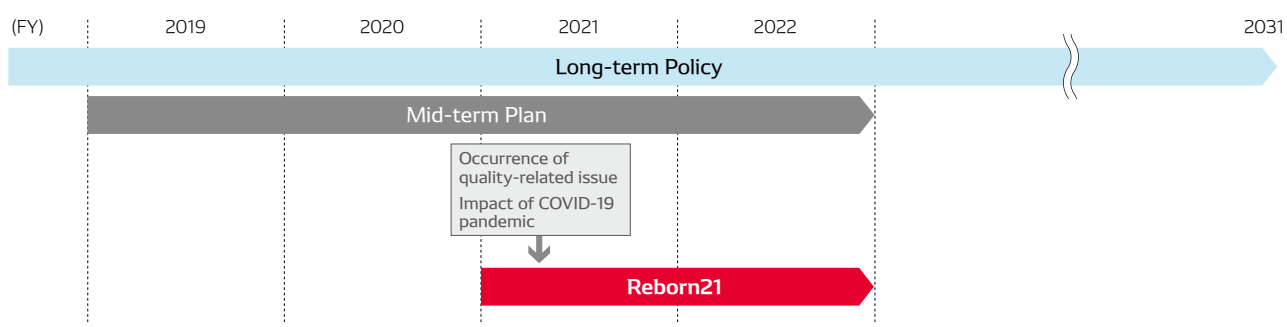

## DENSO Revolution Plan "Reborn21"

Strategy	<p><b>Vision for a future with smiles (worldview)</b></p> <p>Bringing <u>hope</u> for the future for <u>our planet, society, and all people</u></p> <div style="display: flex; justify-content: space-around;"> <div style="border: 1px solid #e91e63; padding: 5px; text-align: center;"> <p><b>Mobility</b></p> <p>Invigorating people and the planet through mobility</p> </div> <div style="border: 1px solid #e91e63; padding: 5px; text-align: center;"> <p><b>Monozukuri</b></p> <p>Invigorating people's creations and the planet</p> </div> <div style="border: 1px solid #e91e63; padding: 5px; text-align: center;"> <p><b>Society</b></p> <p>Invigorating people's lifestyles and society as a whole</p> </div> </div>
	<p><b>Being committed to our "green" and "peace of mind" responsibilities through our business</b></p> <div style="display: flex; justify-content: space-around;"> <div style="border: 1px solid #e91e63; padding: 5px; text-align: center;"> <p><b>Green</b></p> <p>Realizing a carbon-neutral manufacturing industry</p> </div> <div style="border: 1px solid #e91e63; padding: 5px; text-align: center;"> <p><b>Peace of Mind</b></p> <p>① <b>Eliminating traffic accidents</b> and realizing <b>freedom of mobility for all</b></p> <p>② <b>Establishing a society where people are supported and their potential is nurtured</b></p> <p>③ <b>Creating peaceful, comfortable spaces</b></p> </div> </div>
Business practices	<p>Providing customers with the best possible products and services faster than any other company</p> <div style="display: flex; justify-content: space-around;"> <div style="border: 1px solid #e91e63; padding: 5px; text-align: center;"> <p>Core and customization (reestablishing businesses/products)</p> </div> <div style="border: 1px solid #e91e63; padding: 5px; text-align: center;"> <p>Digitization of work (rebuilding work processes)</p> </div> </div>
Personnel and organization that can respond to change	<p>Active personnel and organization that continue to diversify</p> <p>Three changes (mindset, skills, and fields)</p>
Quality	<p><b>Foundation of DENSO's business and trust</b></p> <p>Restoring our quality</p>
Finance	<p>Lowering the break-even point to 70% or less (establishing a structure resilient to change)</p>

# Efforts to Maximize the Value of "Green"

Amid the pressing crisis of climate change, DENSO is exploring the ideal vision for a sustainable mobility society and is accelerating its sustainability management with a view to maximizing the value of "green," which is a target adopted under its Long-term Policy. At the same time, under the aforementioned revolution plan "Reborn21," we are moving forward with efforts to help us become carbon neutral. Furthermore, in 2019 we pledged our support for the Task Force on Climate-related Financial Disclosures (TCFD). Since doing so, we have been carrying out a scenario analysis regarding the impact of climate change on our businesses and the opportunities and risks related to this impact. We have also been examining ways to reflect the results of this analysis in our business strategies. Through these efforts, we have been working to commercialize businesses focused on "green" and pursue avenues that will lead to sustainable business growth. In this section, we introduce the status of the initiatives we are promoting in accordance with the TCFD.

## Scenario Analysis of Business Opportunities and Risks

To understand the impact of climate change on our businesses and to identify climate-related opportunities and risks, we referenced the external scenarios of the International Energy Agency (IEA) and the Intergovernmental Panel on Climate Change (IPCC) and used them as benchmarks for our scenario analysis. Also, while confirming the scenario analysis for the automotive industry, we compared and contrasted this analysis with our awareness of the business environment existing under the Company's Long-term Plan to hypothesize comprehensive scenarios. Upon doing so, we were able to identify climate-related opportunities and risks by analyzing the differences between our Long-term Plan and these scenarios.

### Hypothesizing Scenarios

To correspond to the two axes of transition risks and physical risks, we established three classifications for scenarios: "stagnant," "promotional," and "ambitious." Transition risks in this table are based on the Current Policies Scenario (CPS), the Stated Policies Scenario (STEPS), and the Sustainable Development Scenario (SDS), hypothesized by the IEA (referencing *World Energy Outlook 2019*). The physical risks are based on the RCP8.5, RCP6.0, and RCP2.6 scenarios put forth by the IPCC (referencing *IPCC Fifth Assessment Report*).

		Stagnant (decelerating global warming countermeasures)	Promotional (promoting global warming countermeasures at a steady pace)	Ambitious (accelerating global warming countermeasures)
Transition risks	Hypothesized scenarios	CPS	STEPS	SDS
	Status of hypothesized global warming progression	Uninterrupted trend of rising CO <sub>2</sub> Temperature increase of over 2°C	Current CO <sub>2</sub> levels maintained Temperature increase of over 2°C	CO <sub>2</sub> increases curtailed Temperature increase of less than 1.5°C
	Quantitative business-related indicators	CO <sub>2</sub> emissions 47 Gt (by 2050)	CO <sub>2</sub> emissions 36 Gt (by 2050)	CO <sub>2</sub> emissions 25 Gt (by 2030) → 10 Gt (by 2050)
		EU carbon tax US\$38/t-CO <sub>2</sub> (by 2040)	EU carbon tax US\$43/t-CO <sub>2</sub> (by 2040)	EU carbon tax US\$140/t-CO <sub>2</sub> (by 2040)
		Crude oil US\$134 per barrel (by 2040)	Crude oil US\$103 per barrel (by 2040)	Crude oil US\$59 per barrel (by 2040)
No progress with the introduction of renewable energy		Ratio of renewable energy 23% (2030) → 29% (2050)	Ratio of renewable energy 30% (2030) → 61% (2050)	
Slight increase in ratio of EVs among new vehicles from the 2018 level of 2%	EVs comprising 15% of new vehicles (2030) → 27% (2050)	EVs comprising 47% of new vehicles (2030) → 72% (2050)		
Physical risks	Hypothesized scenarios	RCP8.5	RCP6.0	RCP2.6
	Qualitative business-related indicators	Damage from meteorological disasters	Damage not as significant as RCP8.5, but expected to be more significant than its current level	Damage remains at its current level but potential for significant impact during transition period
		Damage from rising sea levels		
		Damage due to deteriorating ecosystems		
		Damage from food and water shortages		

## Response to Climate-Related Opportunities and Risks

### ➡ Initiatives toward Businesses That Capitalize on the Electrification Trend

Amid expectations of a global increase in electrified vehicles (xEVs) following tighter regulations on fuel efficiency in each country, we are presented with significant opportunities in our Electrification Systems business, which has built up a long track record in electrification technologies, and the Thermal Systems business, which boasts strengths in the development of heat management products that are essential for xEVs. To ensure that these businesses can capitalize on such opportunities, we are refining our advanced technologies, promoting development for the provision of new added value, and striving for business expansion. Meanwhile, electrification presents the risk of a decline in unit sales in our Powertrain Systems business, which handles products for internal combustion engines. However, HVs are currently the main trend in terms of the shift to xEVs, and these vehicles make use of internal combustion engines. Also, we believe we still need to offer products that help reduce fuel consumption to customers who require internal combustion engines, thereby contributing to greenhouse gas reductions.

Scenario for the Commercialization of Electrification as Stated by the IEA (under the assumption of an average temperature increase of 2°C)

Projected sales volume of passenger vehicles (millions of vehicles)

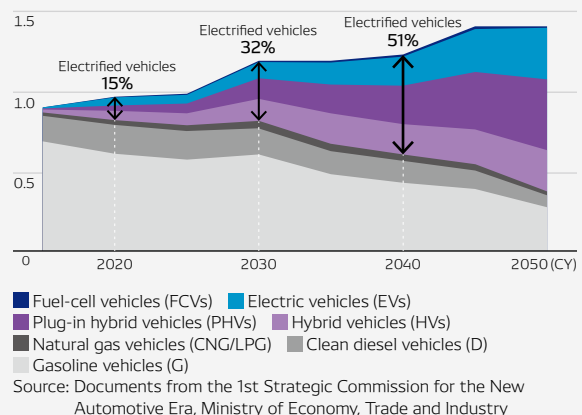



## Analysis of Climate-Related Opportunities and Risks

We performed an analysis on the differences between our awareness of the business environment, which forms the basis of the Long-term Plan, and the circumstances under the scenarios on the left. Items that impacted our businesses at a level equivalent to 5% or more of our overall revenue were identified as key items. As a result, for key items related to transition risks, we identified the inability to respond to fuel efficiency regulations and increasing electrification with our current products as a risk, and innovative technologies as an area where we can create opportunities. For physical risks, the risk of revenue declines due to suspended plant operations following meteorological disasters was identified as a key item. Going forward, we will continue to hold repeated examinations on these key items so that we can analyze their quantitative financial impact, as well as the specific risks and opportunities that they bring to our businesses, in a more detailed manner. We will then take steps to reflect the results of this analysis in our business strategies.

	Key items	Major potential financial impact	Timeframe / Level of impact	Response
Major risks	New controls and regulations placed on our existing products and services	<b>Loss of sales opportunities and declines in revenue due to the impact of regulations on fuel efficiency and exhaust gas</b> <ul style="list-style-type: none"> <li>Decline in unit sales in the powertrain field due to regulations</li> <li>Risk of unit sales in the electrification field not keeping up with demand</li> </ul>	Medium-term / High	Accelerating R&D in the Powertrain Systems and Electrification Systems businesses to respond to new regulations on fuel efficiency and demand for electrification
	Increase in negative feedback from our stakeholders	<b>Decreased access to capital</b> Stakeholders may refuse to invest in the Company if our information disclosure on climate change is insufficient or if our attitude toward the issue is perceived as negative. Share price and funding may also decline as a result, placing pressure on management.	Long-term / Relatively high	Enhance the content of disclosed information and strengthen communication
	Increased severity and occurrence of abnormal weather such as cyclones and floods	<b>Decline in revenue due to suspended plant operations and supply chain disruptions</b> Revenues may decline due to damage to our plants caused by meteorological disasters, including flooding in particular. Additionally, revenues may decline due to suspended plant operations following supply chain disruptions also caused by such disasters.	Long-term / Relatively high	Implement countermeasures for meteorological disasters (including flooding) in new and existing buildings, complement production on a global basis to ensure production continuity, and diversify suppliers for components and other materials
Major opportunities	Utilization of more effective production and logistics processes	<b>Reduced costs due to innovative energy-saving activities</b> We may be able to reduce the amount of energy we use by adopting more effective production methods and promoting innovative energy-saving activities at our plants.	Medium-term / Relatively high	Accelerate the development of energy-saving production technologies at our Production Innovation Center
	Development of new products and services through R&D and technological innovation	<b>Increase in revenue due to higher demand in the fields of electrification and alternative fuel</b> <ul style="list-style-type: none"> <li>Increase in the number of xEVs to respond to fuel efficiency regulations in each country. Forecast sales increase for electrification products of over two-fold in 2025, compared with sales in 2018</li> <li>Rising demand for technologies to improve the heat efficiency of xEVs</li> <li>Enhanced efficiency of internal combustion engines and continued shift toward green technologies, centered on emerging countries</li> </ul>	Long-term / High	Accelerate R&D activities and promote customer proposals in the Electrification Systems, Thermal Systems, and Powertrain Systems businesses to respond to new fuel efficiency regulations and demand for electrification
	Diversification of business activities	<b>Increase in revenue following higher demand for low-carbon technologies</b> The development of technologies that contribute to a low-carbon society will likely progress. Also, there may be higher demand for the industrialization of agriculture and businesses such as biofuel that help absorb CO <sub>2</sub> .	Long-term / Medium	Develop new businesses by expanding the application of our long-cultivated biotechnologies and actively accelerating alliances with business partners

### ➡ Minimum CO<sub>2</sub> Monozukuri

In the production field, we are working proactively to reduce CO<sub>2</sub> emissions, promoting the development of technologies for the production process, and thoroughly implementing energy-saving activities with the participation of all employees. Additionally, we are implementing Just-in-Time (JIT) activities that aim for the utilization and supply of just the right amount of energy at the necessary time. We are also introducing cogeneration systems that utilize city gas, which produces only a small amount of CO<sub>2</sub>, as fuel power for generation and that make use of waste heat. Through these efforts, we aim to halve the amount of energy we use in fiscal 2026 (half the amount of CO<sub>2</sub> emissions per unit compared with fiscal 2013).

Also, the use of cogeneration systems has helped us achieve an in-house power generation rate of 46.0% in Japan (non-consolidated basis).

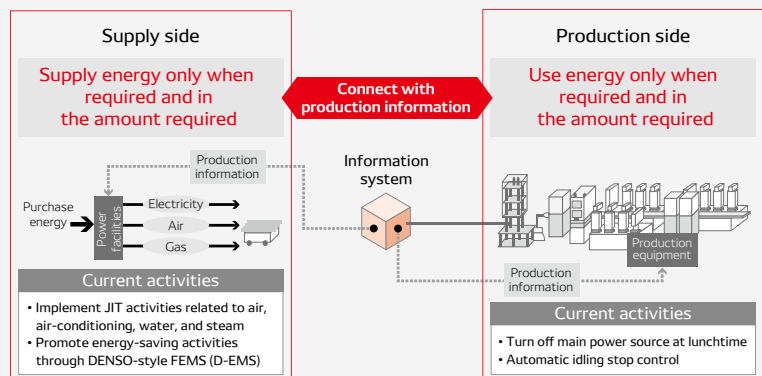



## Governance

DENSO views environmental issues, including climate change, as one of the highest priority issues in the promotion of its sustainability management. Accordingly, DENSO has established KPIs for these issues and is working to achieve them through its business activities (□□ P.34). DENSO has established the Environment Committee as an organization for deliberating and determining important items related to climate change. This committee is chaired by an executive vice president and meets twice a year. At these meetings, members discuss and decide upon important items in the promotion of environmental management, such as formulating medium- to long-term targets and executing investment related to energy conservation. Items that the Environment Committee deems to have a significant impact on the Company's businesses (environmental vision, medium-term management strategies, large-scale investments, etc.) are then deliberated on by the Management Deliberation Meeting or the Board of Directors. The results of such deliberations are reported at meetings of the Management Meeting, in which all officers participate. Furthermore, under the Environment Committee, we have established the Eco Products Subcommittee, the Eco Factory Subcommittee, and the Eco-Friendly Subcommittee, all of which have a senior executive officer serving as chair. These committees manage targets and draft strategies in the areas of products, production, and employee conduct.

Also, the Environment Committee will examine and implement the necessary procedures for sharing environmental issues such as those identified based on the results of scenario analysis. Upon doing so, these issues will be reflected in DENSO's Companywide business plans, which will be promptly executed accordingly.

## Risk Management

Amid the rapidly occurring changes in the business environment, DENSO is striving to ascertain the constantly diversifying risks and implementing risk management from the perspectives of minimizing damage and ensuring business continuity. Climate-related risks are reported to the Environment Committee, which identifies key items and clarifies the Company's response. We recognize climate-related risks (physical risks) as one of the major risks facing DENSO. Based on this awareness, we are strengthening our response to these risks on a Groupwide basis.

Strengthening Natural Disaster Risk Response : □□ P.93

## Strategies, Indicators, and Targets

To maximize the value of "green" adopted under the Long-term Policy, we formulated DENSO Eco Vision 2025. This vision adopts the three targets of "Energy 1/2," "Clean x 2," and "Green x 2," collectively referred to as "Target 3." These targets are to be achieved by fiscal 2026.

### ENERGY 1/2

Reduce CO<sub>2</sub> emissions by half through the use of technologies that resolve issues related to global warming, energy, and resources

### CLEAN x 2

Halve the impact of environmentally hazardous substances and the amount of waste we generate

### GREEN x 2

Improve the fuel efficiency of cars, greenify plants and surrounding areas, and enhance employees' environmental awareness

In addition, to realize our eco visions, we formulate environmental actions plans every five years, which lay out specific targets and plans, and take action accordingly. At the same time, we take steps to confirm the level of achievement for each target.

Also, the main KPIs (up to 2020) under the current five-year Environmental Action Plan (sixth phase) are as follows.

- Overall CO<sub>2</sub> emissions\*<sup>1</sup> from new vehicles equipped with DENSO products: 30% reduction (compared with fiscal 2013)
- CO<sub>2</sub> emissions per unit\*<sup>2</sup> following production activities: 30% reduction (non-consolidated), 40% reduction (Group companies) (compared with fiscal 2013)
- CO<sub>2</sub> emissions per unit in logistics: 8% reduction (non-consolidated) (compared with fiscal 2013)
- Waste per unit: 25% reduction (non-consolidated) (compared with fiscal 2013)
- Water use per unit: 2.5% reduction (non-consolidated) (compared with fiscal 2016), etc.

Also, we are moving forward with the formulation of the new Eco Vision focused on 2050 with the aim of becoming carbon neutral. At the same time, we will continue to reflect the quantitative and qualitative indicators of climate-related scenario analysis within our specific business strategies and environmental action plans, taking into account the impact of climate-related opportunities and risks based on different scenarios.

\*1 The estimated portion of CO<sub>2</sub> emissions for which DENSO's products are directly responsible

\*2 Limited to CO<sub>2</sub> from energy sources



For details on Eco Vision  
<https://www.denso.com/global/en/csr/environment-report/management/ecovision/ecovision/#/MOVIE/>



For details on Environmental Action Plan  
<https://www.denso.com/global/en/about-us/sustainability/environment/action-plan/>



Please see Performance Data (Environment) for details on the progress toward our targets.  
<https://www.denso.com/global/en/about-us/sustainability/library/environment-data/>





# 2 Foundation for Creating New Value

- 42 Reinforcing Our Strengths
  - 42 Research and Development
  - 44 *Monozukuri*
  - 46 *Hitozukuri*
- 48 Strengthening Capitals
  - 48 Financial Capital
    - 50 CFO Message
  - 54 Human Capital
  - 56 Manufacturing Capital
    - 57 CQO Message
  - 58 Intellectual Capital
  - 59 Social and Relationship Capital
  - 61 Strengthening Our Organizational Capabilities

## Reinforcing Our Strengths

# Research and Development

By accurately ascertaining social needs, DENSO has created competitive products with a commitment to world-firsts. In our R&D activities, which have been the starting point for the value creation that allows us to create such products, we are planning technologies in a wide range of fields with a focus on five to 20 years in the future and strengthening our R&D structure. Additionally, to create optimal products in each region, enhance the appeal of automobiles, and contribute to the future automotive society, we operate technical centers and laboratories around the world. By combining the knowledge of DENSO on a global scale, we will work to create the future mobility society.

### The Key to Our Strengths

#### Foresight

Commitment to world-firsts



#### Creating Over 130 World-First Products

We have established “contributing to a better world by creating value together with a vision for the future” as the DENSO Philosophy. By keenly ascertaining social changes, we have been engaging in product development with a commitment to world-firsts since our establishment. We have developed over 130 world-first products, including gas injection heat pump systems, common rail systems, millimeter-wave radar, and ejectors, which have provided us with a driving force for growth.

#### Speed

Global Development Network

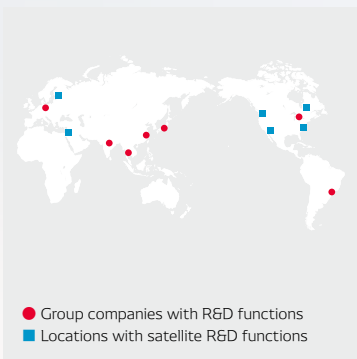

#### Technical Centers in Seven Regions throughout the World and Laboratories in Epicenters of Innovation

We have established technical centers in seven regions across the globe, in addition to offices in Canada, Israel, Silicon Valley, and other epicenters of innovation. Through this Global Development Network, we promptly incorporate diversified regional needs into our development process to create competitive products, which are subsequently delivered to our customers.

#### Advanced Technologies

Advanced research with a view to the future



#### Advanced Research That Estimates and Anticipates the Future Mobility Society

Since establishing the Fundamental Research Center in 1991 (renamed the Advanced Technology Research Laboratories in 2017), we have been carrying out research and development with a focus on five to 20 years in the future in an effort to develop and popularize techniques that will comprehensively resolve social issues over 25 years or more.

We perform advanced technology research in a wide range of fields, from power semiconductors such as silicon carbide (SiC) to key AI technologies for automated driving, which has led to commercialization over the near term.

**R&D** Further Reinforcing Our Strengths**Establishing MIRISE Technologies—A Company That Handles the Advanced Development of Next-Generation In-Vehicle Semiconductors**

Recently, there has been an increase in the installation of electronic controls in vehicles. The number of in-vehicle semiconductors has also grown, and the performance of these semiconductors has continuously improved. In addition, within the progression of CASE (connected, autonomous, shared, electric) aimed at realizing the mobility society of the future, there is a need to develop next-generation, in-vehicle semiconductors, which provide the key to technological innovation.

To address this need, DENSO established MIRISE Technologies Corporation in April 2020 together with Toyota Motor Corporation, combining Toyota's knowledge of mobility and cars with DENSO's knowledge of in-vehicle components. This company conducts research and advanced development of next-generation in-vehicle semiconductors. Specifically, MIRISE engages in the advanced development of unique, groundbreaking semiconductors newly created by Toyota, a car manufacturer, and DENSO, a component manufacturer. By sufficiently leveraging synergistic effects between Toyota and DENSO, the company will contribute to the realization of a new mobility society that offers peace of mind and comfort.

MIRISE makes efforts toward three fields of technological development: **1** power electronics, **2** sensing, and **3** SoC (System-on-a-Chip). In the power electronics field, the company promotes R&D mainly for in-house production (including contract manufacturing) by leveraging semiconductor material technologies as well as manufacturing and design technologies accumulated by Toyota and DENSO in the field of electrification technologies, centered on hybrid vehicles. In the sensing field, the company works on development for in-house production and joint development with business partners. In the SoC field, the company is working to strengthen its ability to determine the specifications of optimal SoCs for mobility in the future. To achieve the above goals based on a speedy and competitive system, MIRISE is actively pursuing cooperation with such organizations as semiconductor-related companies, car manufacturers, universities and research institutions, start-up companies, and servicers and strengthening the recruitment of semiconductor engineers.

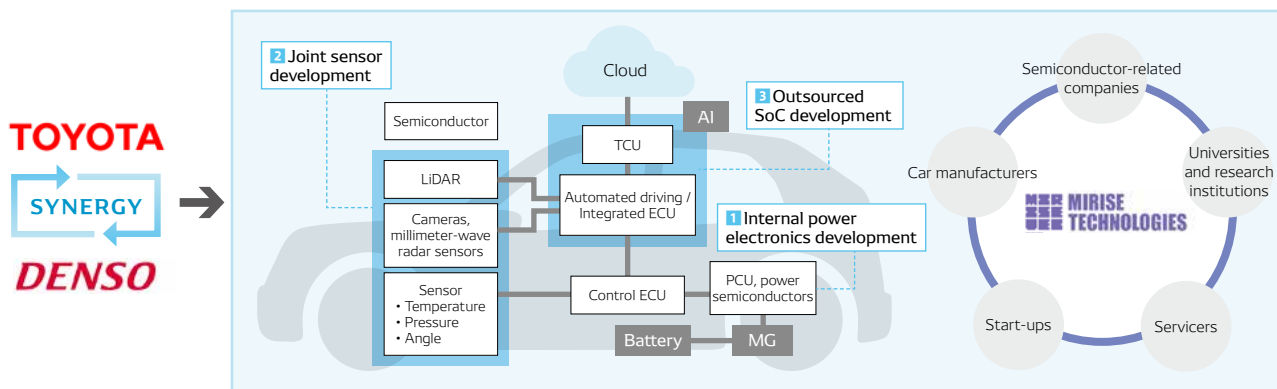
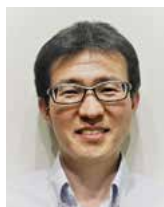
**TOPIC****Development of Next-Generation LiDAR Technologies****DENSO****Koichi Oyama**

Sensor R&D Division,  
MIRISE Technologies  
Corporation

**TOYOTA****Hiroomi Eguchi**

Planning &  
Administration Division,  
MIRISE Technologies  
Corporation

Leveraging the strength of being a joint venture company of Toyota and DENSO, MIRISE engages in the research and advanced development of LiDAR technologies. The body of conventional mechanically operated mirror mechanisms is quite large, and accordingly there is a need to make these mechanisms more compact based on the perspective of ease of installation and cost. MIRISE is therefore taking on the challenge of developing electronic scanning mechanisms that control light using a semiconductor chip. As universities and start-up companies in North America are leading the world in the development of this kind of technology, DENSO and Toyota's North American bases have decided to collaborate and pursue joint-development activities with start-up companies affiliated with the Massachusetts Institute of Technology. These start-up companies are taking the initiative ahead of other companies in the promotion of verification tests on technologies that can realize the ideal performance for LiDAR systems from the perspectives of compactness and low cost. Through collaboration with these start-ups, we will accelerate our development activities and share information on highly competitive technologies.

# 02 Monozukuri

Since its inception, DENSO's *Monozukuri* has thoroughly integrated in-house technologies. Through *Monozukuri* positive steps are taken to design and manufacture equipment, production lines, materials, and processing methods. This enables us to provide society with the world's most advanced groundbreaking technologies and products conceived by our R&D. We have striven to develop speedy and efficient production lines and compact unique facilities, as well as streamline distribution and inspection with our own production technology, and we have built a *DANTOTSU*\* plant that performs *Monozukuri* at a *DANTOTSU* price. This has enabled us to also ensure high efficiency and high quality and offer competitiveness and added value to our products.

\* *DANTOTSU*: A *DANTOTSU* plant is one that undertakes *Monozukuri* at a *DANTOTSU* (outstanding) price. A *DANTOTSU* plant is at such a high level that it cannot be compared to other plants.

## The Key to Our Strengths

### Technological Capabilities

World-leading production engineering



### Production Structure That Enables Mass Production of World-First and World-Only Products

DENSO leverages world-class micro-processing, paying attention to detail down to the 1/1000mm, and an assembly line that improves production efficiency and quality. DENSO also supports world-first products and the world's highest level of product performance and quality from a *Monozukuri* perspective by designing and manufacturing its own equipment and production lines.

### Analytical Capabilities

Factory-IoT that brings out the knowledge of people to the greatest extent possible



### Working to Improve Productivity That Connects People and Factories Globally

We take our abundance of data on people, products, and facilities and convert it into valuable information, such as information on signs of equipment flaws and information that contributes to expert know-how. We offer such information to people that desire it at the times they need it and in a format that they prefer. By doing so, we are accelerating activities aimed at making improvements and contributing to the growth of people. We aim to form global linkages between our 130 plants in an effort to improve productivity by 30% on a Groupwide basis.

### Frontline Capabilities

Excellent factory (EF) activities that realize growth for both factories and people



### Promoting EF Activities Focused on Eliminating Product Defects and Lost Operational Time

Our plant general managers lead the way with EF activities in which all factory workers participate. By focusing on making improvements to areas that are easily overlooked and establishing production lines that create high-quality products, EF activities make it easy to identify issues within our factories. Through the continued efforts of all employees to address issues when they do occur, EF activities cultivate human resources that are dedicated to making improvements and also help us realize the top level of competitiveness in each area of operation.

## Monozukuri Further Reinforcing Our Strengths

### Evolving *Monozukuri* through DENSO-style Factory-IoT

Based on the concept of working in a manner that seems as if all DENSO employees are working under one roof, DENSO has been promoting **1** the global sharing of know-how on frontline improvements and **2** the in-house development of Factory-Internet of Things (F-IoT) platforms. DENSO has also been working to share and effectively utilize know-how on a Groupwide basis. In these ways, the Company has taken steps to strengthen its *Monozukuri* capabilities.

#### 1 Global Sharing of Know-How on Frontline Improvements

F-IoT platforms consist of a wide range of apps that help enhance overall equipment efficiency and reduce the rate of product defects. Within these apps, we have incorporated DENSO's know-how on frontline improvements. However, what is most important in terms of F-IoT platforms is the co-creation activities between people and equipment. To that end, we are gathering data on a global basis to make full use of various apps. We are also pursuing activities that change the way we approach our work on the front lines. Through these means, we are promoting growth for both people and equipment. F-IoT platforms help us expand these kinds of activities around the world and provide us with a mechanism for the global sharing of know-how.

#### Factory-IoT Platforms

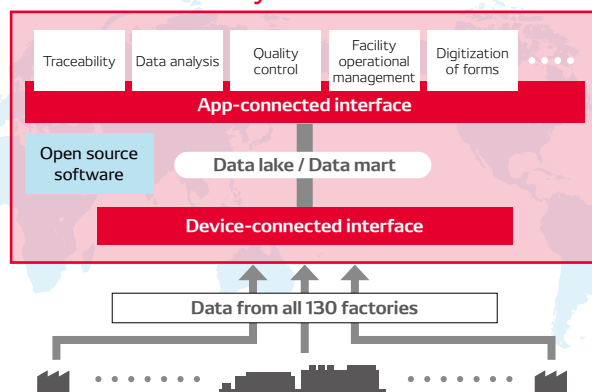

#### 2 In-House Development of F-IoT Platforms

Platforms serve as a part of a production system. For example, in the same manner that production lines increase the performance of facilities and conveyors in conjunction with increased production volumes, platforms enhance data processing capabilities. Accordingly, platforms must be able to enact a flexible response in accordance with the speed of changes and improvements on the front lines of production. DENSO has realized the open development of highly competitive platforms in-house by internalizing the production of functions that need to conform to frontline changes and utilizing open-source software for all other functions.

#### CASE Taking on the Challenge of Agile Development

We are taking on the challenge of developing agile software (scrum) at not only our Sakura-machi office, which is located near our head office, but also at our offices in Shin-Yokohama and Akihabara. In the future, we will establish software improvement workstations in each of our plants in an effort to fully utilize platforms and continuously develop beneficial software on-site. In these ways, we will accelerate frontline improvements.

##### Example of Initiative 1:

We promote software development while enhancing the skills of our programmers through the use of a method called "pair programming," in which programmers share information and learn together. This method allows us to swiftly adopt new technologies and refine the development capabilities of entire programming teams.

##### Example of Initiative 2:

Using the whole surface of a wall, we visualize backlogs (development tasks) so that our programming teams can share information on who is doing what tasks, what delays are occurring, and where issues are happening. In this way, our programming team members are able to help each other as they engage in software development.



Note: Due to the COVID-19 pandemic, we are developing software entirely on a remote basis. By managing backlogs digitally, we have been able to maintain the same level of productivity with our development as when our teams were working in an office environment.

## TOPIC

### Promoting Self-Reliance with In-House Production of Masks—A DENSO First!

As mask shortages gradually became a serious issue due to the COVID-19 pandemic, we commenced the production of masks at in-house facilities and contributed to society by becoming self-reliant in mask procurement. At the beginning of March 2020, we launched a project that involved designing and building mask production facilities, creating a clean production environment, establishing a quality control structure, and setting up a supply chain for the procurement and distribution of materials. The project took approximately one-and-a-half months, with mask production beginning on April 27, 2020. For this project, professionals from various divisions gathered together and quickly took action in the areas of machine building, trial production, production management, procurement, and production technologies. We therefore believe the success of this project is truly symbolic of DENSO's *Monozukuri* activities, which emphasize in-house production and collaboration.



Mask production at a manufacturing site



# Hitozukuri

“The best products are made by the best human resources.”  
DENSO has positioned human resources as its most important management resource. Accordingly, the Company has focused on the training and skill development of employees based on the idea that human resource development supports R&D and *Monozukuri*. We are also promoting a broad range of initiatives on a global scale to develop leaders who can take charge of new businesses and oversee the future of DENSO so that we can continue to achieve continuous growth going forward.

## The Key to Our Strengths

The Spirit of Our Founding

Diversity

Skills

DENSO Spirit



Global human resource development



Cultivation of young technicians



### Boldly Taking on New Challenges No Matter What the Circumstances

The DENSO Spirit is one of foresight, credibility, and collaboration. It also establishes a culture of values and beliefs that DENSO has cultivated since its founding in 1949. Accordingly, the DENSO Spirit is shared among all employees. As an action guideline that provides the driving force for contributing to the automotive society and the lifestyles of people as well as the source of our competitiveness, the DENSO Spirit permeates the actions of the 170,000 DENSO Group employees around the world. Guided by this spirit, we are using the passion and ambition of all our employees as the driving force for implementing our day-to-day work procedures and accelerating innovation amid this period of dramatic change.

DENSO Spirit: □□ P.1



For details on the DENSO Spirit:  
<https://www.denso.com/global/en/about-us/corporate-info/philosophy/denso-spirit/>



### Introducing a Global Common Personnel Management System to Promote the Active Role of a Diverse Group of Employees

In January 2016, DENSO introduced a global common personnel management system targeting the nearly 2,300 members of senior management at its headquarters and at each Group company. This system incorporates a “Global Individual Grade” that focuses on the individual capabilities of senior management members. By using a common grading tool to evaluate and promote its senior staff, DENSO allows its personnel around the world to develop their careers on a global scale. Through this system, DENSO aims to further develop its global business by recruiting employees with a diverse range of values and abilities.



### Nurturing Advanced Technicians as the Key to Corporate Growth

To nurture advanced engineers and technicians, DENSO has been operating the DENSO Industrial School (offering industrial high school and specialized vocational high school courses), which carries on the tradition of the technical training schools established in 1954. In addition to domestic Group companies, this school supports the development of technicians from certain suppliers and overseas offices. Many young technicians who participated in our educational systems have gone on to become WorldSkills Competition medalists who compete at the world’s highest level. At the 45th WorldSkills Competition held in August 2019, 20 of our technicians from Japan, Thailand, Indonesia, Vietnam, and Mexico competed in 10 events, winning a total of six medals including gold, silver, and bronze medals.



**Hitozukuri** Further Reinforcing Our Strengths**Creating Work Environments Where Employees Can Continue to Pursue Challenges Regardless of Age**

In Japan, where the working population is expected to rapidly decline in the future, the active role of a diverse group of employees, including women, senior citizens, and foreigners, has become even more important. Through the promotion of diversity and inclusion, DENSO is establishing working environments where all employees—regardless of age, gender, or nationality—can play an active role and is promoting efforts to encourage the growth of its employees' individual capabilities.

**Promoting the Active Role of Employees Who Are Senior Citizens**

We anticipate the number of employees at DENSO who are senior citizens will increase significantly going forward. Accordingly, we have taken steps to create work environments and systems where such employees can leverage their individual skills and abilities with enthusiasm.

In fiscal 2021, we made revisions to our human resources system for the reemployment of employees over 60. With these revisions, we introduced a new system that changed the previously uniform work duties for employees over 60 and established four different courses of work duties. Under this new system, we are encouraging employees to take on challenges in a variety of roles, regardless of their age. In particular, many of our senior citizen employees are now playing an active role in core areas such as production, quality assurance, and *Hitozukuri*.

## Overview of the Course-Specific Reemployment System

## Course-specific roles

1	<b>Newly established</b>	Role for leading a wide scope of projects across businesses, regions, and functions
2	<b>Newly established</b>	Role for leading key projects across business divisions
3	<b>Newly established</b>	Role for leading business operations and frontline operations as a professional
4		Role for promoting business operations in a way that leverages experience and insight (possible to select flexible workstyles based on individual situations, including shorter workweeks)

## TOPIC

**Contributing to Society While Continuing to Learn and Grow****Hirohito Nakagawa**

Career Expert  
Human Resources and  
Organizational Development  
Office  
Human Resources Division

This year, the course-specific reemployment system was introduced just as I reached the age of retirement, and I was rehired in one of the newly established courses. Currently, I am responsible for Companywide organizational development projects.

The main roles of my job involve everything from working to address the issues facing each office to creating organizational development programs and engaging in facilitation. Just as my predecessors before me, I aim to leave behind a foundation for the future of DENSO. Guided by this aim, I am working on a daily basis to promote *Hitozukuri* and establish organizations that will serve as a foundation for the future.

To be honest, I was extremely happy that, through the course-specific reemployment system, my supervisor recognized the contributions I have made to the Company and assigned me to an even more significant role. This has truly enhanced my motivation in my new role. Meanwhile, although I obviously draw on my previous experiences and insight in my new role, it does not necessarily mean that such experiences and insight will be useful today. Accordingly, I have once again recognized the importance of continuing to learn and grow as I pursue my work.

My future goal is to reach a level where I am recognized by society as a professional in organizational development. To reach this goal, I am participating in external training and various other programs. Regardless of my age, I want to continue to take on new challenges and maintain a presence as an older employee that younger ones can look up to.

# Strengthening Capitals



## Financial Capital

### Outline of Efforts to Strengthen Financial Capital

DENSO allocates management resources in an optimal manner while giving consideration not only to profits/losses but also the composition of its balance sheet. We are also reconsidering our capital structure to strike a balance between financial security and efficiency as we work to reduce the weighted average cost of capital. Furthermore, we will strive to realize sustainable growth and enhance our corporate value by investing effectively in key areas such as R&D, capital expenditures, shareholder returns, and M&A.

#### Target KPIs (Fiscal 2021 target)

Ratio of depreciation	Total return ratio
No more than	Between
<b>6%</b>	<b>30%–50%</b>

### Characteristics of DENSO's Financial Capital (Fiscal 2020 results)

Weighted average cost of capital (WACC)

**6%–7%**

Equity ratio attributable to owners of the parent company

**60.1%**

### Approach to Assets, Liabilities, and Capital

While giving sufficient consideration to financial security, we will revise the composition of our balance sheet to realize a balance with financial efficiency.

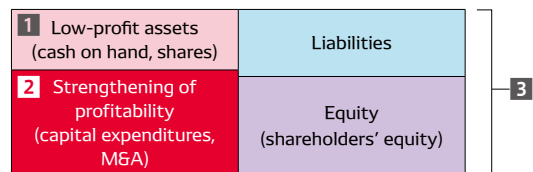

#### 1 Reduction of low-profit assets (improvement of capital efficiency)

Minimization of cash on hand (monthly sales comparisons: 2-month period → 1.2-month period)

- Reduce the amount of cash set aside for emergencies and respond to the repayment of short-term loans
- Leverage the GCMS\* between Group companies and loan funds between regions

Promote the reduction of strategic shareholdings

\* Global Cash Management System

#### Progress Thus Far

Reduced cash on hand to a 1.6-month period (monthly sales comparisons) by March 31, 2020

Completed the introduction of GCMS and reduced uneven asset distribution by region

Reduced strategic shareholdings by ¥14.8 billion through the sale of all shares held in eight stocks and a portion of shares held in four stocks

#### 2 Strengthening of profitability (disciplined growth investments)

Invest in growth fields (machinery and equipment, M&A/alliances)

Establish rigorous investment evaluation indicators for capital expenditures/M&A

Clarify products and businesses that should be discontinued based on quantitative judgments

#### Progress Thus Far

Carried out investment in 17 projects, from start-up companies to large enterprises

Completed the introduction of business potential assessment using IRR\* for M&A in fiscal 2020 and expanded this assessment to include capital expenditures in fiscal 2021

\* Internal rate of return

#### 3 Optimization of capital structure (reduction in WACC)

Stable long-term shareholder returns and proactive utilization of loans

- Procure a large amount of funds at lower interest rates
  - Leverage high credit rating to procure funds at low costs
  - Ensure that funds can be raised swiftly when necessary and diversify procurement methods

#### Progress Thus Far

Commenced examinations on shareholder returns that aim for a debt-equity balance in consideration of financial security and efficiency as well as on the utilization of interest-bearing debt

## Approach to Growth Investments

### R&D Expenditure

As a company that drives the market with its technologies, we will continue to allocate approximately ¥500.0 billion in cash a year toward investment. We will maintain this level even amid the growing uncertainty in the current business environment in an effort to continue to create sources for future profit. Meanwhile, as development domains continue to expand, including the response to CASE, we will control cash flows through efficient software development, standardization, the utilization of digital tools, and other efforts to enhance efficiency. Through these means, we will set aside resources for upfront investments in fields that will help us better prepare for future technologies.

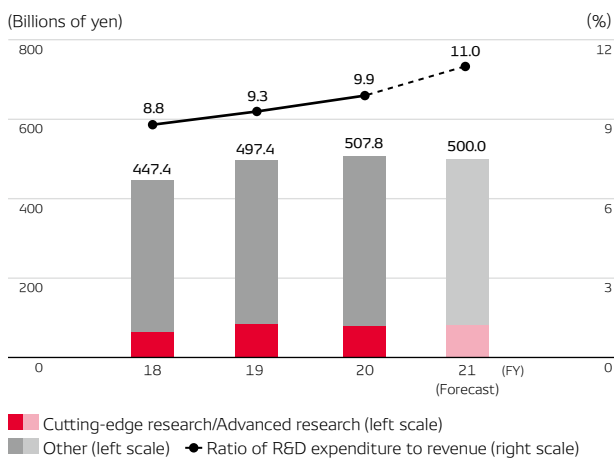

### Capital Expenditures / Depreciation

In the past, there were periods when DENSO had an extremely high ratio of depreciation to revenue. There were also periods when this ratio was low as we narrowed down investments to an excessive degree. We have now determined that a ratio of depreciation to revenue of within 6% is ideal for operating our businesses under a robust structure, and we will continue to pursue more efficient, highly disciplined investment in such areas as *DANTOTSU* plants and 1/N production equipment. While we currently expect to exceed this targeted level due to the temporarily rapid decline in revenue caused by the COVID-19 pandemic, we will aim for a ratio within 6% for the future through disciplined investment and a recovery in revenue.

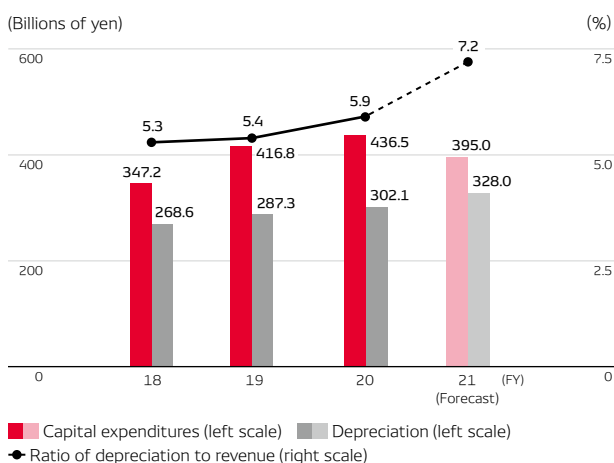

### Shareholder Returns

We aim to offer stable long-term returns to our shareholders. In addition to striving to increase dividend amounts on an ongoing basis, we will also flexibly acquire treasury stock in consideration of trends in our share price and our ideal capital structure.

#### Dividends per Share / Dividend Payout Ratio

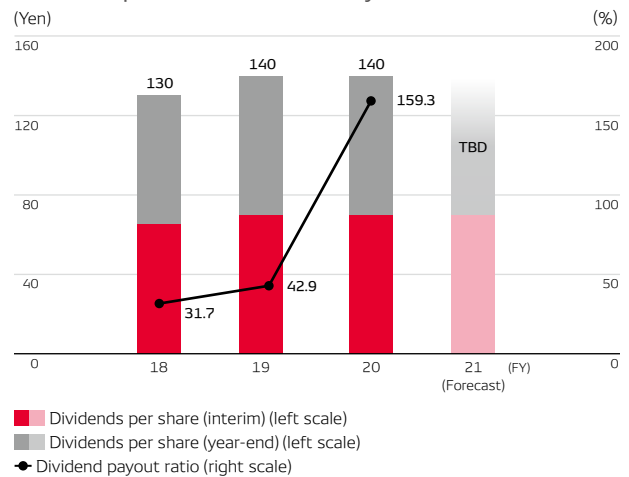

#### Total Dividend Amount / Amount of Treasury Stock Acquired / Total Return Ratio

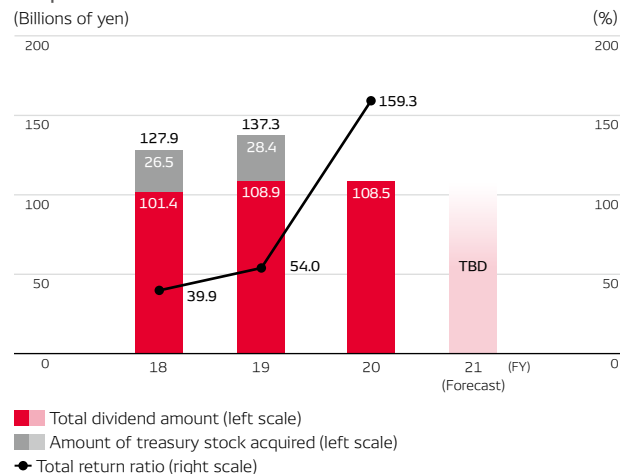

### M&A and Business Alliances

To respond to the dramatic changes in the business environment, we aim to acquire the necessary resources and technologies and secure new business models. We are also examining investment in a proactive manner.

We have been further accelerating investment initiatives since fiscal 2018. In fiscal 2020, we carried out investment in 17 projects.

When making investments, we have been working to enhance our judgment capabilities to determine whether an investment aligns with our aims. Furthermore, from a quantitative perspective, we adopt IRR as our primary standard for deciding on an investment. Also, after making an investment, we monitor profit ratio and the progress of activities for each quarter in an effort to steadily secure investment returns.

## CFO Message

# Reaching a New Stage for Growth While Holding Ongoing Dialogue with Capital Markets

### Reforms That We Can Only Make in the “With COVID-19” Era

In fiscal 2020, despite a generally steady performance up through the third quarter, the spread of COVID-19 starting from the fourth quarter had a significant impact on our consolidated financial performance. Additionally, in the second half, we recorded a quality cost provision for fuel pumps. As a result, we saw significant year-on-year declines in fiscal 2020, with revenue decreasing 3.9%, to ¥5,153.5 billion, operating profit declining 80.7%, to ¥61.1 billion, and profit attributable to owners of the parent company falling 73.2%, to ¥68.1 billion.

In fiscal 2021 thus far, revenue declined nearly 50% in both April and May, compared with the same periods of the previous fiscal year, as each country

implemented lockdowns due to COVID-19. Revenue decreases were held to around 25% in June. From July on, revenue decreases have been controlled at 10% or less. Now, Toyota Motor Corporation and other car manufacturers have finally returned to full operation, and we will likely enter into a period of recovery. We therefore expect that our performance in the second half of fiscal 2021 will improve to around the same level as that of the second half of fiscal 2020. Accordingly, we forecast around a 10% year-on-year decline in revenue for the whole of fiscal 2021. In view of this, we anticipate a trend of gradual recovery going forward. However, under uncertain circumstances in which we cannot forecast the resolution of the COVID-19 pandemic, the issue we now face is how to secure profit and strengthen our corporate structure.

Specifically, we will lower our break-even point from around its current level of 80% to 70% in an effort to promote improvements to our corporate structure so that we can avoid posting a loss even in the event revenue declines 30%. To accomplish this, we must strengthen our financial discipline and promote the reduction of fixed costs. At the same time, we need to exercise more discretion in the execution of capital expenditures, which have grown significantly over the past several years. Meanwhile, R&D expenditures provide the source of our competitiveness, and we therefore will continue such investment to thoroughly promote improvements to our development efficiency. In addition, we will invest in growth fields such as CASE.



### Yasushi Matsui

Chief Financial Officer  
Senior Executive Officer

We are a manufacturing company that has a commitment to technologies. At the same time, as I will explain later, we are a company supported by our balance sheet, which boasts ample self-funding and an abundance of cash. Rather than viewing our current situation as a crisis, I believe it is a once-in-a-lifetime opportunity for us to improve our financial structure. Through a balanced approach that ensures we do not lose our long-cultivated strengths, we aim to realize a more robust financial structure going forward.

### Positive Boost Provided by Electrification and Automated Driving

Within the so-called CASE domain, we will likely see a halt in the trend toward sharing (S) due to the impact of the COVID-19 pandemic. Meanwhile, we expect the trends toward electrification (E) and autonomous driving (A), two areas in which DENSO is particularly focusing its efforts, to accelerate going forward.

In terms of electrification, there have been trends to which we need to pay close attention, including the shift in the stance of the Chinese government, which had been wholly devoted to electric vehicles (EVs), to embrace hybrid vehicles (HVs) as well. HVs are more complicated than EVs as they make use of specialized, sophisticated subsystems that require coordinated control of the engine and the motor. Accordingly, the number of companies that can develop and manufacture these subsystems is quite small. In addition to boasting industry-leading technologies and the number of units installed, we also possess production bases for HV products in Japan, the United States, and China and have already secured the necessary number of engineers. From the perspective of our technological superiority, which we have consistently worked to refine over the past 20 years, and market growth potential, we believe the electrification field will become a growth driver for us in the future.

Additionally, for automated driving Toyota vehicles that have adopted our advanced driver assistance systems (ADAS) received the highest rating of five stars from the European evaluation institution Euro NCAP in 2016. These systems include radar and light detection and ranging (LiDAR) remote sensing features as well as sensing features that distinguish between people, cars, and obstacles outside the vehicle. We believe that such features will serve as

strengths that we can leverage in fully automated driving in the future.

Going forward, we believe that Tier 1 suppliers will need to possess both electrification and automated driving systems and have the ability to propose comprehensive solutions and platform systems that cover all aspects of the automobile. Drawing on our various insights on automobile functions such as running, turning, stopping, and heat management, which we have accumulated through the manufacturing of engines, braking systems, and air-conditioners, we aim to lead the global market in electrification and automated driving.

### Realizing Growth and Enhancing Corporate Value by Strengthening Profitability

Even if the supply side of the automobile industry is approaching a recovery, there is still a growing level of uncertainty regarding the outlook for consumer demand. For this reason, it is essential to emphasize growth based on profit, and important indicators in this regard are our various profit margins and financial structure, as well as our investment efficiency and other indicators that measure corporate value.

Going forward, we will maintain our target for reaching an operating margin of 10% by fiscal 2026, which we adopted under the Long-term Plan. If we can restore the rate of our growth, then clearing the full-year target for fiscal 2022 of operating margin of 8% or higher should also be more than possible. In terms of revenue, we find ourselves in an operating environment where we cannot hope for soaring market growth. Therefore, we will aim to achieve growth not by excessively pursuing quantity but rather by enhancing quality.

Actually, we have already been producing results with our efforts to improve profitability. For example, the development volume of software that can respond to CASE and other technologies is increasing year by year. In the development process for such software, we have been striving to reduce rework and automate inspection processes and processes for confirming specification documents. This, in turn, has helped us utilize dispatched engineers more efficiently. In our manufacturing processes, we have realized enhanced productivity and the reduction of product defects through the introduction of IoT at our plants in Japan. We have now reached a stage where we will roll out similar efforts at our overseas plants. Also, we are promoting

## CFO Message

management with a greater awareness toward improving corporate value, and, by having our return on invested capital (ROIC) exceed our weighted average cost of capital (WACC) over the medium to long term, we will build a corporate structure that will enable us to enhance corporate value in a sustainable manner.

Specifically, since fiscal 2020 we have adopted and strictly applied internal rate of return (IRR) as the primary standard for evaluating our investments. We have also determined hurdle rates for each country based on our WACC. After evaluating each new capital expenditure and equity investment based on these standards, we carefully select and execute such investments accordingly.

In the future, we will apply these same kinds of quantitative evaluation methods for our existing businesses and products as well, thereby accelerating improvements to our business and product portfolios.

### M&A Strategy for Accelerating Growth

In the once-in-a-century paradigm shift that is occurring in the automotive industry, it is becoming increasingly important to rebalance our business portfolio. To that end, we are picking up the pace of discussions on development strategies from the perspective of our business portfolio. These discussions focus on three domains: the shift to in-house production, the utilization of external insight, and the reduction of costs. In addition, we are actively pursuing M&A.

Centered on the Alliance Promotion Department, we are exploring business partner candidates in Japan and overseas in consideration of the three perspectives listed below. Also, the four members of our Investment Council are undertaking multifaceted examinations of M&A projects based on their individual expertise in the fields of finance, technology, law, and risk.

- 1 Short term: Investment to complement or acquire resources for the present**  
(Example: Securing engineers through the investment in or acquisition of software companies)
- 2 Medium term: Investment to realize horizontal division of labor for production and technological development and enhance elemental technologies**  
(Example: Investment in a cooperating semiconductor manufacturer)
- 3 Long term: Investment to acquire near-future technologies and next-generation business models**  
(Example: Collaboration with venture companies)

We concluded agreements for 21 and 17 M&A projects in fiscal 2019 and fiscal 2020, respectively. These agreements were reached with a broad range of companies, from start-ups to large enterprises.

While we have been pursuing such investments on an ongoing basis, we are now presented with the greatest opportunity in recent years to further promote such investments in light of the relatively inexpensive stock prices of automotive companies at the moment. Also, we are considering investment that would allow us to obtain know-how in non-automotive fields and instantly expand the scale of our revenue. In particular, FA and agricultural business entities are prime candidates for this kind of investment.

### Reforms to Make Our Financial Foundation More Robust

To make our financial foundation more robust, we are promoting reforms that center on the two pillars of “reduction of low-profit assets” and “optimization of capital structure.”

For “reduction of low-profit assets,” we have been working to significantly minimize cash on hand. In the past, our cash management efforts involved simply lending money to each region in a flexible manner. However, through the introduction of our Global Cash Management System (GCMS), which involves loaning money between regions in a timely fashion, we have eliminated uneven funding distribution by region. Furthermore, by leveraging our high level of credibility and strong relationships with financial institutions, we have reduced the amount of cash set aside for emergencies by half. We have also reduced the level of cash on hand from an equivalent 2-month period of monthly sales to a 1.6-month period as of March 31, 2020. Although cash on hand is now temporarily increasing due to the COVID-19 pandemic, we will continue efforts toward further minimization over the medium to long term.

Also, we have been taking proactive steps to reduce strategic shareholdings. Since fiscal 2020, we have been evaluating and determining strategic shareholdings in an even stricter manner, considering qualitative aspects, such as how holding such shares can lead to management improvements, and quantitative aspects, such as whether or not the return on holding such shares will exceed capital costs. In addition, since fiscal 2020 we have been reducing the number of listed shares we hold to 16 stocks.

By continuing these efforts, we will actively work to reduce low-profit assets and boost our Company-wide capital efficiency going forward.

In terms of "optimization of capital structure," we will strive to maintain our current high level of financial stability (long-term credit rating of AA+ from R&I and A- from S&P) while utilizing interest-bearing debt and examining ways to balance our capital structure, giving sufficient consideration to financial efficiency. We will also promote reforms from a financial perspective to ensure that efforts to lower WACC and strengthen profitability effectively contribute to corporate value improvement.

### Shareholder Returns and Dialogue with Capital Markets

Stable, long-term shareholder returns are essential in establishing trust-based relationships with our shareholders and other investors.

Despite facing several major issues in the second half of fiscal 2020, we were able to maintain interim and year-end dividend payments, each at ¥70 per share, with a dividend payout ratio of 159.3%. For fiscal 2021, we are also planning an interim dividend payment of ¥70 per share. To the greatest extent possible, we will strive to raise the dividend payment level on a continuous basis going forward. Moreover, we will examine dividend policies that consider the cost of shareholders' equity. Also, we will remain committed to our stance of flexibly acquiring treasury stock, taking into account the trend in our share price and our ideal capital structure.

Furthermore, we will enhance our communication abilities in our investor relations (IR) activities. It is not enough to disclose information by accurately and sincerely conveying the details of our performance from the previous fiscal year. With an awareness of a certain level of uncertainty, corporations must be able to communicate their own vision for the future. I believe we have reached an era in which corporations cannot be silent to earn the trust of the market. Rather, trust must now be earned through active communication. The adoption of quantitative targets for fiscal 2026 was a change we made based on an understanding of this situation. As CFO, I will work to accelerate similar changes going forward.

Additionally, in the same manner as we have traditionally done with financial information, we will actively disclose information on non-financial fields

such as ESG, for which investor expectations are growing. Activities in non-financial fields are essential for a company like DENSO, which aims to be inspiring by maximizing the value of "green" and "peace of mind," two themes of our Long-term Policy, through the enhancement of both social and corporate value. We therefore aim to improve our stakeholders' understanding of our non-financial information.

We will also continue to strengthen our dialogue with capital markets. As a first-time effort, in May 2019 we invited investors, analysts, and members of the media to attend DENSO Dialogue Day, a business briefing session. Also, we hold overseas roadshows in North America, Europe, and Asia three times a year. During 2020, we will continue to engage in straightforward communication efforts while flexibly responding to individual needs, as we have done this year by holding our roadshows via video conference.

### Closing

DENSO boasts robust technological capabilities and productivity in the fields of electrification and automated driving. These give us the potential to achieve genuine growth. For business expansion moving forward, we will place the utmost emphasis on profitability, with an awareness of not only operating margin but also ROIC. While we have maintained a sound financial foundation, we are aware that there have been various opinions and disagreements regarding our capital efficiency. While continuing to listen carefully to the opinions of our shareholders, we will steadily make changes to our vision for the Company's management.

Among investors, there has been a recent trend of hesitation toward investing in the automotive industry. This is likely because investors feel that, as the CASE revolution progresses, there will be increasing pressure to make massive investments without fully knowing when the benefits of these investments can be reaped. However, if you carefully analyze the details of our financial results, you will see that the results of our investments are already starting to peak out, and that, conversely, we are producing solid results with efforts to streamline our operations. I believe you will also be convinced that we are just starting to enter into a period when our investments and other efforts will bear fruit. I would like to ask that you look forward in anticipation as we approach a new stage for growth as a "Reborn DENSO."



# Human Capital

## Outline of Efforts to Strengthen Human Capital

At DENSO, we believe that corporate growth is achieved when each of our employees leverages his or her abilities to the greatest extent possible and leads an active and fulfilling lifestyle. Presently, we are dedicated to pursuing diversity, which supports our global business development. To that end, we are moving forward with a wide range of efforts further empowering our diverse group of employees, including strengthening the recruitment of and promoting an active role for women as well as promoting the employment of people with disabilities. In addition, to ensure that our employees pursue their work with a high level of motivation, we are endeavoring to ensure the mental and physical health of our employees and establish a safe and secure workplace in which they can carry out their duties with a sense of fulfillment. We are also encouraging our employees to pursue healthy lifestyles.

Target KPI (Fiscal 2021 target)

Number of female employees in management positions:

**100**

(non-consolidated)

## Characteristics of DENSO's Human Capital (Fiscal 2020 results)

Ratio of overseas employees

**55%**

Ratio of paid leave taken

**101.4%**  
(non-consolidated)

Turnover ratio

**0.78%**  
(non-consolidated)

## Promoting Diversity & Inclusion

We value new ideas that are created by our employees with diverse backgrounds, and we believe that nurturing kind-hearted, thoughtful employees who respect each other's individuality is essential for realizing sustainable growth. To this end, we are promoting diversity and inclusion, which involves making full use of the skills and perspectives of our employees around the world in order to realize an organizational environment and culture that embraces all individuals, regardless of personal attributes such as gender, age, nationality, disability, career history, and value systems, thereby allowing a diverse group of employees to work with enthusiasm and energy.

### Promotion Structure

In order to clarify global policies, share initiatives and policy progress in each region, as well as debate common challenges, DENSO is pursuing activities such as establishing a Global Diversity & Inclusion Committee made up of executives, representatives of each region, and other members, in addition to a promotion committee system in each region.

### 1 Promoting the Active Role of Female Employees

We have made progress in providing career-building support and in reforming workstyles so that women can advance their careers throughout each major life event. For example, we have introduced various support programs that far surpass the legal requirements, such as childcare leave, shortened work hours, and mobile working, thereby enhancing the flexibility of our female employees in terms of working location and work hours. In addition, we are making efforts to raise Companywide awareness of the issues facing women in the workplace by

conducting training that provides opportunities for women to consider their careers and approach to work (Number and Ratio of Female Employees in Managerial Positions: □ P.97).

Results of Our Efforts (fiscal 2019 → fiscal 2020)

Number of female employees in management positions:

**86 → 103** (non-consolidated)

### 2 Promoting the Employment of People with Disabilities

Since starting the regular employment of persons with disabilities in 1978, DENSO has actively worked to expand employment and occupational opportunities for people with disabilities.

In 1984, we established DENSO Taiyo Co., Ltd., a special purpose subsidiary that primarily hires people with physical disabilities. This company is engaged in the production of such products as vehicle instrument clusters and smart keys. In 2016, we established the special purpose subsidiary DENSO Blossom Co., Ltd. This company offers employment opportunities to people with mental illnesses and intellectual disabilities and is engaged primarily in clerical work.

At the moment, we employ over 700 people with disabilities on a Groupwide basis that includes our head office and these two subsidiaries.



## Health and Productivity Management\*1

Good physical and mental health is essential for ensuring the happiness of our employees and their families, and provides the source for working in a lively and energetic manner.

DENSO positions promoting the health of its employees as an important management task, and announced its Health Declaration\*2 in September 2016. At the same time, to encourage activities that promote employee health and raise the level of health awareness in the workplace, DENSO is working to enhance its health-related initiatives from the perspective of both physical and mental health.

Also, to promote health management at each Group company in Japan and overseas, we formulated the DENSO Group Health and Productivity Management Basic Principles in February 2019. By sharing these principles globally and implementing health management activities based on the conditions at each company and in each country, we will improve the health awareness (health literacy) of each employee and establish a more comfortable working environment across the entire Group.

As a result of such efforts, DENSO was included in the Health & Productivity Stock Selection,\*3 a joint initiative carried out by the Ministry of Economy, Trade and Industry (METI) and the Tokyo Stock Exchange (TSE), as well as the Superior Health & Productivity Companies (the White 500) Program,\*4 which is promoted by the TSE and the Nippon Kenko Kaigi (Japan Health Council), for the fourth year in a row. In addition, 18 domestic Group companies have also been included in the White 500 Program.



\*1 "Health and productivity management" is a registered trademark of the NPO Kenko Keiei Kenkyukai.

\*2 To read the entire DENSO Health Declaration, please refer to the "Sustainability Information" section of the Company's corporate website.

\*3 The Health & Productivity Stock Selection selects listed companies on the TSE that strategically consider and implement health and productivity management for their employees as a top management priority. The Health & Productivity Stock Selection introduces the selected corporations as an attractive investment option for investors who prioritize the improvement of corporate value from a long-term perspective. Through this effort, METI and the TSE aim to encourage corporations to further pursue efforts in "health and productivity management."

\*4 The Superior Health & Productivity Companies (the White 500) Program is not restricted to listed companies and recognizes corporations that implement superior health and productivity management in collaboration with insurers such as health insurance associations. This program commenced in 2017.



Click here for details on DENSO's initiatives toward health management  
<https://www.denso.com/global/en/about-us/sustainability/society/health/>



## Ways of Working with Tremendous Speed and Efficiency

By eliminating unnecessary processes, meetings, tasks, and other work-related procedures to improve productivity, we have made strides in reforms that reduce the number of work hours for our employees. Going forward, we will not only continue striving to reduce work hours but also pursue reforms focused on enhancing the motivation of all employees and heightening their job satisfaction.

We view the eight factors in the diagram below as essential elements in providing a fulfilling work experience. To enhance these factors, we will move forward with three reforms (work

reform, management reform, and communication reform), in addition to promoting health and productivity management and establishing employee-friendly working environments.

### Work Reform

By introducing new ways of working, such as teleworking and innovating work processes using IT tools, we have established working environments that make it easier for employees to concentrate and exercise their individual capabilities.

### Management Reform

We are promoting educational activities aimed at our management and establishing a framework for enhancing dialogue between employees and their supervisors. In these ways, we have strengthened management that produces results from the mutual synergies created by a diverse pool of talent.

### Communication Reform

We are providing financial assistance for reform activities that help employees pursue self-study and encourage them to make each other better. We are also promoting office reforms that provide an even more fulfilling work experience through revitalized communication. In these ways, we have increased the level of communication among employees and foster a lively workplace culture.

Through these three reforms, we will provide an even more fulfilling work experience to each employee, accelerate the speed of our business execution, and invigorate the workplace, thereby strengthening Companywide competitiveness.

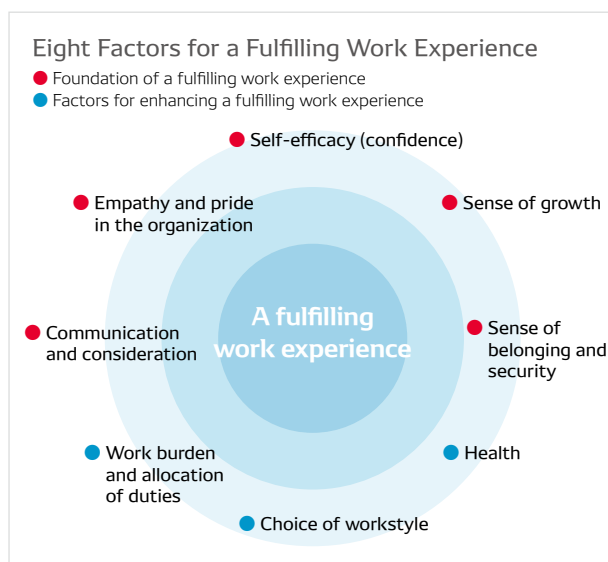



## Manufacturing Capital

### Outline of Efforts to Strengthen Manufacturing Capital

DENSO is committed to thoroughly integrating its in-house technologies and has established manufacturing bases that bring together its unique production technologies to create high added value (*Monozukuri*, □ P.44). Through such efforts, we have been strengthening our manufacturing capital so that we can provide competitive products on a global basis. We are also building a global production structure to enhance the satisfaction of customers in all areas of operations in terms of quality, cost, and delivery. At the same time, we are striving to reduce our environmental burden within our business activities through the pursuit of world-leading environmental efficiency and high productivity. In these ways, we are working to evolve our manufacturing bases.

#### Target KPI (Fiscal 2021 target)

Productivity enhancement through the introduction of F-IoT:

**30%**  
(compared with fiscal 2016)

### Characteristics of DENSO's Manufacturing Capital (Fiscal 2020 results)

Capital expenditures  
**¥436.5 billion**

CO<sub>2</sub> emissions per unit  
**37% reduction**  
(compared with fiscal 2013,  
non-consolidated)

In-house power generation ratio\*  
**46.0%**  
(non-consolidated)

\* Ratio of electricity generated through cogeneration to total electricity used

### Global Production Structure That Achieves Outstanding QCD

Guided by the basic principle of manufacturing products in close proximity to our customers, we have built a highly competitive production structure in North America, Europe, China, greater Asia (including India), and Japan. In addition, we are working to optimize our manufacturing bases by giving consideration to product characteristics, such as product size and processing difficulty, and local characteristics, such as the employment environment.

Meanwhile, to win out against the global competition, at our manufacturing bases around the world we aim to achieve leading levels of QCD\* in each region and realize manufacturing that can withstand change. Based on this aim, we are proceeding with the creation of *DANTOTSU* plants through steady technological innovation and EF activities in which all employees participate (□ P.44). Furthermore, we are introducing F-IoT in order to share information on the conditions and improvement measures at each plant in real time, enhance improvement synergies on a global scale, and accelerate the speed at which improvement measures are carried out (□ P.44–45). In this manner, we aspire to create plants that leverage the knowledge of people to the greatest extent possible.

\* Quality, cost, and delivery

### Initiatives toward Water Risks

In recent years, in addition to the prevention of water contamination and other pollution, a variety of water problems including droughts and floods are intensifying, resulting in stronger demand for efforts to counter water risks. For this reason, DENSO has identified water risks. Based on evaluations that take into account regional characteristics (locational factors), we promote the reduction of these risks by strengthening relevant efforts to respond to water risks and sharing case studies of such measures. We also ensure emergency water resources in accordance with regional needs and actively promote rainwater usage. Furthermore, we are undertaking efforts to address water risks in our supply chain based on our understanding of current conditions.

#### Case Study JIT Water Management

Just-in-Time (JIT) water management is a management system that supplies water at the necessary time, in the necessary amount, and to the necessary place through the establishment of a comprehensive management model that covers facilities for everything from water supply to water disposal. Through JIT water management, we are able to ascertain the day water was used, the time it was disposed, the necessary water amounts, and the concentration of drainage in a manner specific to each production line and facility. Furthermore, this system separates industrial water, city water, and circulated water, in addition to adjusting water consumption amounts and controlling the amount of chemicals introduced in accordance with drainage concentration.

## CQO Message

# Pursuing Companywide Efforts to Return to "DENSO Quality"

DENSO has always embraced the challenge of competing for the Deming Prize, the most prestigious award in the world for quality control. In 1961, DENSO became only the second company from the Japanese automotive industry to receive this award. After receiving the Deming Prize, DENSO adopted the slogan "DENSO Quality" and, guided by this slogan, the Company continued to earn the trust of customers and achieve growth based on management that puts quality and the customer first. However, our largest-ever quality-related issue has now come to light, and this development has shaken the foundation of "DENSO Quality."

To remedy this situation as quickly as possible, we have adopted "Recommitting to DENSO Quality" as our quality policy in fiscal 2021. Under this policy, we are working to "establish a foundation for regaining trust" and "enhance the quality of our design and manufacturing."

In terms of establishing a foundation for regaining trust, we will comprehensively evaluate not only quality-related complaints that have materialized in the market but also customer complaints regarding certain products for which we were unable to identify the reason the complaint was made as no abnormalities were found. In this way, we are working to eliminate any factors that could lead to critical or massive defects. For enhancing design quality, design software is not only becoming more extensive and complicated, year by year, the development volume for such software is increasing. To enhance the quality of our design software, we are systematically promoting automation and labor-saving efforts through the introduction of tools that provide comprehensive support from the upstream to the downstream of software development. Furthermore, for newly developed products, we have made it a requirement to confirm that there is a sufficient amount of design leeway in terms of the relationship between the stress applied by the environment in which the product is used and the strength of the product itself. For enhancing our manufacturing quality, we are steadily making improvements to the degree to which we can achieve process assurance. We are also continuing to engage in activities that aim to enhance the reliability of our manufacturing processes by making systematic improvements to our frontline operations. Additionally, we are taking steps to establish a route-tracing system that minimizes any inconvenience caused to customers in the rare event that a defective product makes it through the manufacturing process.

In this way, we are making efforts to enhance the quality of our design and manufacturing from both hard and soft perspectives. In addition to these efforts, we have adopted the slogan "Reborn21," under which we aim to make our corporate structure leaner and more robust so that we can respond to the changing times and the changing external environment and provide new value. This slogan declares our commitment to start anew in fiscal 2022 by realizing a genuine self-transformation. With "Reborn21," we will enhance added value in terms of our contributions to customers (strategies), the way we promote our operations, and our workstyle itself (personnel and organization). By doing so, we will recommit to delivering "DENSO Quality."

I believe that good quality comes from a sound workplace. To ensure that our workplace, which provides the source of good quality, is not weakened by this quality-related issue, we in management will spearhead efforts to establish even sounder workplaces with unflinching determination.

We take pride in the fact that we are a company that embraces real craftsmanship. To that end, we will strive to promptly return to DENSO's true nature as a quality-first company by fulfilling our mission to society and the world and drawing on our true strengths to the greatest extent possible. In this way, we will make Companywide efforts to once again restore DENSO's high reputation for exceeding customer and social expectations. We would like to ask for your continued support as we pursue these endeavors going forward.

## Yasushi Yamanaka

Chief Quality Officer  
Executive Vice President





# Intellectual Capital

## Outline of Efforts to Strengthen Intellectual Capital

To realize its Long-term Policy for 2030, DENSO is promoting its intellectual property (IP) strategy in unison with its business strategies. In particular, in the four focus fields established under the Long-term Plan for 2025 of electrification, advanced safety and automated driving, connected cars, and non-automotive businesses (factory automation and agriculture), we are focusing on building a patent portfolio and promoting IP activities related to open innovation. We are also supporting efforts to expand our businesses and achieve sustainable growth by strategically utilizing the patents that we have acquired.

### Target KPI

Annual R&D Expenditure  
Approx.  
**¥500.0**  
billion a year

## Characteristics of DENSO's Intellectual Capital (Fiscal 2020 results)

R&D expenditure (ratio to revenue)	Number of patent applications filed	Number of patents held
<b>¥507.8 billion (9.9%)</b>	Approx. <b>6,700</b>	Approx. <b>43,000</b>

## Promotion of IP Strategy

DENSO is promoting its IP strategy in unison with its business strategies. Added value for automobiles is beginning to shift toward the CASE domain. Under these circumstances, there are three main initiatives we are promoting in order to win out against the competition, which now includes not only major players from the automotive industry but also ICT companies and start-ups. These initiatives are (1) sharpen our competitive edge in the automotive industry by leveraging our IP rights, (2) create partnerships with companies in other industries based on IP collaboration, and (3) promote the external procurement of IP (break free from the "everything in-house" mentality). Guided by these three initiatives, we will realize an advantageous business ecosystem through the utilization of IP.

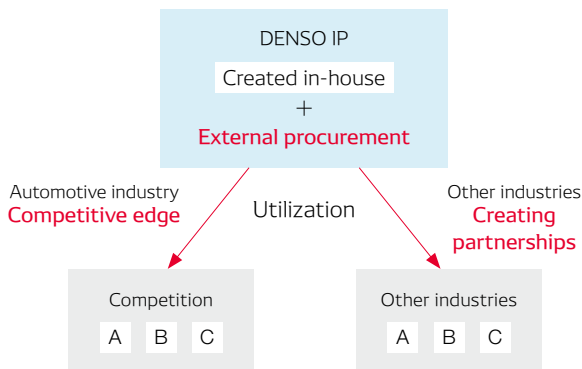

## Strengthening Our Global IP System

To support overseas development and design, we have set up IP organizations at our development and design bases in North America, Europe, and China, thereby strengthening our efforts to acquire IP rights for local inventions and examine other companies' IP rights. Furthermore, at our locations in North America and Europe, we deploy patent attorneys to provide support in patent disputes. In China, we protect the DENSO brand by taking measures against counterfeit products and copyright infringements. At overseas locations where we have yet to set up an IP organization, we have established systems to reward inventions and provide education on intellectual properties. In doing so, we are working to encourage local IP activities.

In addition, as part of our efforts in global IP collaboration, we hold the Global IP Conference. This conference brings together members of IP organizations at our locations around the world with the aim of resolving local IP issues and invigorating our IP activities in all regions of operation.

## Results of IP Activities in Fiscal 2020

DENSO invests around 9% of its revenue in R&D activities and, as a result, has steadily secured patents around the globe. In 2019, DENSO was ranked second in the automotive industry, including car manufacturers, for the number of newly registered patents in Japan, and eighth in the United States.



## Social and Relationship Capital

### Outline of Efforts to Strengthen Social and Relationship Capital

DENSO advances its business activities while interacting with various stakeholders. DENSO believes that establishing good relationships with its stakeholders is an essential part of improving corporate value. DENSO also clarifies its responsibility to stakeholders in its business activities, and continues to engage in dialogue with stakeholders as a helpful means of avoiding self-satisfying activities that are biased by its own logic and preconceptions. DENSO fulfills its social responsibility while reflecting stakeholder opinions and the needs of society in its corporate activities.

### Characteristics of DENSO's Social and Relationship Capital (Fiscal 2020 results)

Number of suppliers  
Approx. **6,100**

Local procurement rate  
Approx. **80%**

Number of dialogues with institutional investors (total number of companies)  
Approx. **800**

### Efforts to Encourage Dialogue with Stakeholders

Stakeholders	Efforts to encourage dialogue	Fiscal 2020 results
Customers	<b>Customer Consultation Center</b> We provide the feedback we receive from customers via the Customer Consultation Center to relevant departments, which we then use to offer even better products and services.	Approx. <b>5,100</b> inquiries related to products
Employees	<b>Global Conference</b> At the Global Conference, directors and members of management from our locations around the world gather to hold a discussion on realizing the Long-term Policy and implementing long-term plans.	Approx. <b>300</b> participants from around the world
Suppliers	<b>General Meeting of Suppliers</b> As a measure to deepen interactions with our suppliers, we hold the General Meeting of Suppliers to provide information about our procurement policy and the initiatives of each business division.	Approx. <b>380</b> suppliers from around the world
Shareholders and Investors	<b>Ordinary General Meeting of Shareholders</b> At the Ordinary General Meeting of Shareholders, the chairman of the Board provides a report on the Company's future initiatives and answers questions from the shareholders, in addition to performing other duties. <b>Dialogue with Investors</b> We hold dialogues with investors through briefings on results and future strategies, individual interviews and teleconferences, overseas road shows, and other means.	Approx. <b>800</b> dialogues with institutional investors (total number of companies)
Local Communities	<b>Community Service Day</b> DENSO has designated a day ("Community Service Day") for employees to give back to their local communities. For Community Service Day, our employees carry out unique social contribution activities. <b>Corporate Sports</b> We offer encouragement to our employees through sports activities. At the same time, we value the connections we make with local communities through sports.	Approx. <b>46,100</b> Community Service Day participants (employees)

## Promotion of Sustainability Together with Our Suppliers

Guided by the basic policies of open and fair business practices and responsible procurement activities, DENSO promotes sustainability together with its suppliers around the world in order to continue to fulfill its social responsibilities within the supply chain on a Groupwide basis.

### Promotion of Sustainability Based on the Supplier Sustainability Guidelines

DENSO has determined the Supplier Sustainability Guidelines and shares these guidelines with its roughly 6,100 suppliers, requesting that they carry out procurement in line with the content of these guidelines. We also regularly ask our suppliers to assess their own CSR practices through self-diagnostic sheets. When necessary, DENSO employees responsible for CSR procurement visit suppliers to conduct assessments, hold dialogues, and recommend improvements. When beginning transactions with a new supplier, we conclude a basic transaction contract that addresses issues such as compliance, protection of human rights, environmental conservation, and occupational safety.

### Thorough Implementation of Green Procurement According to the Green Procurement Guidelines

In the environment field, DENSO has formulated the DENSO Group's Green Procurement Guidelines based on the Group's basic environmental policy, Eco Vision. These guidelines cover such matters as managing and reducing materials with high environmental burden and establishing environmental management systems. We ask that our suppliers engage in green procurement and management based on these guidelines.

### Initiatives to Address the Issue of Conflict Minerals

Minerals that originate from conflict areas are mined through non-humanitarian acts, and it is said that these minerals are used to finance armed groups. Accordingly, conflict minerals have become a significant social problem in regard to human rights.

DENSO recognizes that conflict minerals represent one of the most significant social issues within the supply chain. Therefore, in addition to establishing response measures, we are making revisions to our Supplier Sustainability Guidelines in light of this issue. We currently ask that all our suppliers carry out an investigation into conflict minerals. Going forward, we will collaborate with our suppliers to eliminate the use of materials that are suspected to come from conflict areas.

## ESG-Related External Evaluation

DENSO has received high evaluation in terms of socially responsible investment (SRI), consistently being selected for inclusion in indices in Japan and overseas, including the Ethibel Sustainability Index, which is a representative SRI index in Europe.



2020 CONSTITUENT MSCI JAPAN  
ESG SELECT LEADERS INDEX

2020 CONSTITUENT MSCI JAPAN  
EMPOWERING WOMEN INDEX (WIN)



FTSE4Good



FTSE Blossom  
Japan

- Notes: 1. The inclusion of DENSO CORPORATION in any MSCI index, and the use of MSCI logos, trademarks, service marks or index names herein, do not constitute a sponsorship, endorsement or promotion of DENSO CORPORATION by MSCI or any of its affiliates. The MSCI indexes are the exclusive property of MSCI. MSCI and the MSCI index names and logos are trademarks or service marks of MSCI or its affiliates.
2. FTSE Russell (the trading name of International Limited and Frank Company) confirms that DENSO CORPORATION has been independently assessed according to the FTSE4Good criteria, and has satisfied the requirements to become a constituent of the FTSE4Good Index Series. Created by the global index provider FTSE Russell, the FTSE4Good Index Series is designed to measure the performance of companies demonstrating strong Environmental, Social and Governance (ESG) practices. The FTSE4Good indices are used by a wide variety of market participants to create and assess responsible investment funds and other products.
3. Evaluations listed are those received as of September 30, 2020.

# Strengthening Our Organizational Capabilities

To reach the growth targets adopted in its Long-term Plan, DENSO must transition to an organization that acts with unprecedented levels of speed and can invigorate the workplace. To that end, DENSO has adopted the Five Pillars of Management Reform and is working to realize significant change in its management structure to enhance its organizational capabilities and compete in a challenging business environment.

## Five Pillars of Management Reform

### 1 Enhancement of Vehicle Perspective and Streamlining of Technological Development

To effectively develop complex systems for automated driving and other technologies, we need to optimize our development from the perspective of vehicle-based systems. We are therefore reorganizing our businesses to accomplish just that. Also, as part of our strategy to achieve overwhelmingly high levels of differentiation in terms of components and systems, we are streamlining the technological development of our four key devices: ECUs, semiconductors, sensors, and motors, so that we can realize growth in new business domains and enhance the profitability of existing in-vehicle technology business.



### 2 Advanced R&D Function to Realize Agile Development Globally

We have established satellite R&D teams in Finland, Israel, and other epicenters of innovation in order to promote the development of highly competitive products that meet the needs of customers. Through these teams, we will collaborate with various local partners, such as universities, research institutions, and start-up companies, as we form alliances under shared goals. We will also promote new technological development that leverages the unique characteristics of local regions.

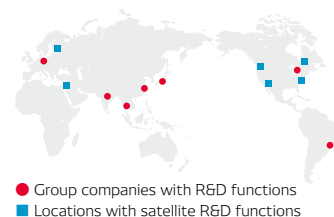

### 3 Business Unit Evolution and Smaller but Stronger Headquarters

We will increase the responsibility and authority of each business unit in an effort to increase the speed of our management and bolster our competitiveness. We will also streamline our head office by revising our personnel allocation from a "zero-based" perspective. At the same time, we will aim to transition to an organization that can create new value at unprecedented speeds.



### 4 Global Management with Optimal Use of Group and Regional Power

Our regional supervisors, who are responsible for achieving regional business targets, make proactive efforts through regionally independent management at a speed that best fits their individual region. Their efforts will help us transform into an organization that can realize faster decision-making and business execution on a global scale.



### 5 Ways of Working with Tremendous Speed and Efficiency

We will establish an environment in which employees can work without being bound by the constraints of location and time while working to reform our various business processes, thereby ensuring productivity and realizing a work-life balance for our employees. In these ways, we aim to become a company with incomparable frontline capabilities and where employees can work with passion and a smile.



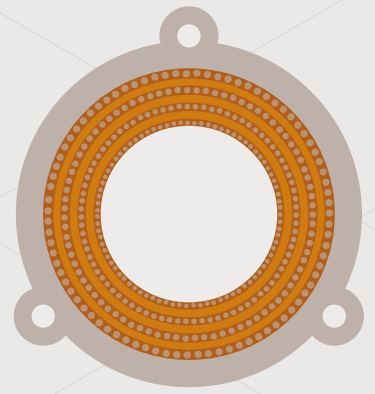
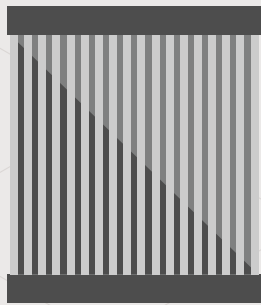

# 3 Overview by Product

63 Business Portfolio and Value Creation

64 Thermal Systems

66 Powertrain Systems

68 Electrification Systems

70 Mobility Electronics

72 Sensors & Semiconductors

74 Non-Automotive Businesses  
(FA and Agriculture)

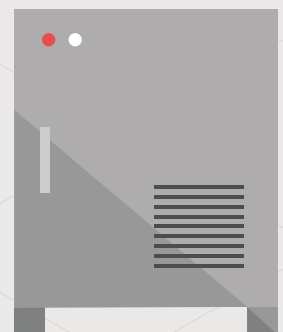
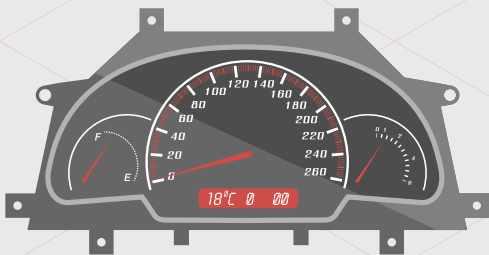
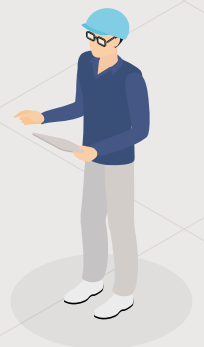
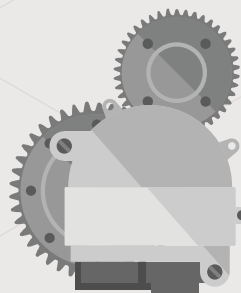
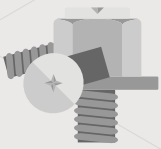
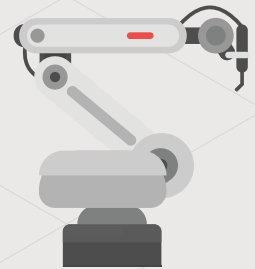
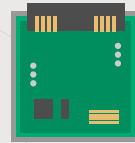
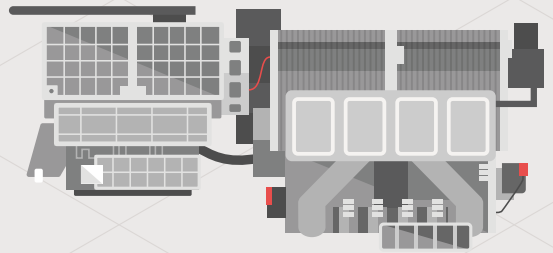



# Business Portfolio and Value Creation

DENSO operates six core businesses in a broad range of domains, centered on automotive-related fields. DENSO has established a business portfolio for creating new value that can address the future needs of the mobility society. Going forward DENSO will strive to maximize value in its six core businesses so that it can enhance the potential of the mobility society.

## Business Composition and Focus Fields

In its automotive businesses, DENSO supplies an extensive lineup of products and systems as a Tier 1 supplier that is trusted by car manufacturers around the globe. We operate a total of five automotive businesses, starting with the Thermal Systems Business that manufactures such products as in-vehicle air-conditioning systems, for which we boast the No. 1 global share. In addition, we operate the Powertrain Systems Business, which can manufacture powertrains for all types of vehicles. We also operate the Electrification Systems, Mobility Electronics, and Sensors & Semiconductors businesses, which hold the key to the future of mobility-related development. These five businesses contribute to development in three of our focus fields: electrification, advanced safety and automated driving, and connected cars.

Furthermore, in our non-automotive businesses, we leverage the technologies cultivated in our automotive businesses to contribute to the field of factory automation (FA) and agriculture.

Four Focus Fields: □ P.25

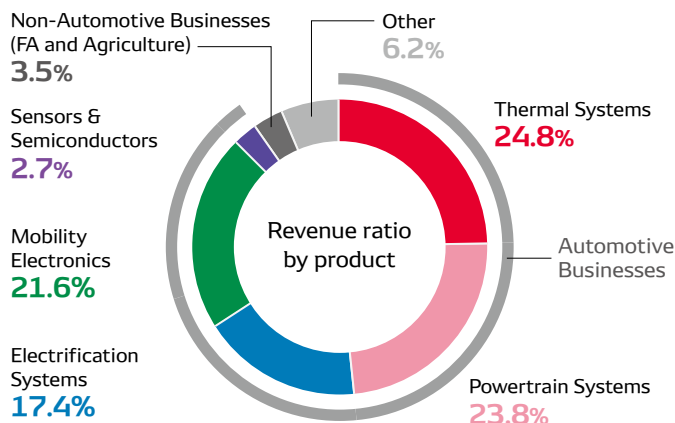

Four Focus Fields



## Value Creation in Our Businesses

In each of our six core businesses, we contribute to development in our four focus fields and work to maximize the value of “green” and “peace of mind,” which are adopted as part of our Long-term Policy. In addition, through our business activities, we will work to resolve the issues highlighted in the SDGs and create new value for the future mobility society.

Segment	Relevant focus fields		Contribution to Long-term Policy (value of green and peace of mind)		Relevant SDGs
Thermal Systems	Electrification	Advanced Safety and Automated Driving	Green	Peace of Mind	3, 7, 9, 11, 12, 13, 17
	Connected Cars	Non-Automotive Businesses (FA and Agriculture)			
Powertrain Systems	Electrification	Advanced Safety and Automated Driving	Green	Peace of Mind	4, 5, 7, 8, 9, 11, 12, 13, 17
	Connected Cars	Non-Automotive Businesses (FA and Agriculture)			
Electrification Systems	Electrification	Advanced Safety and Automated Driving	Green	Peace of Mind	7, 9, 12, 13, 17
	Connected Cars	Non-Automotive Businesses (FA and Agriculture)			
Mobility Electronics	Electrification	Advanced Safety and Automated Driving	Green	Peace of Mind	3, 7, 8, 9, 11, 12, 13, 17
	Connected Cars	Non-Automotive Businesses (FA and Agriculture)			
Sensors & Semiconductors	Electrification	Advanced Safety and Automated Driving	Green	Peace of Mind	2, 3, 6, 7, 8, 9, 12, 13, 17
	Connected Cars	Non-Automotive Businesses (FA and Agriculture)			
Non-Automotive Businesses (FA and Agriculture)	Electrification	Advanced Safety and Automated Driving	Green	Peace of Mind	2, 3, 8, 9, 10, 11, 12, 15, 17
	Connected Cars	Non-Automotive Businesses (FA and Agriculture)			

# THERMAL SYSTEMS



## Providing safe, comfortable systems that use the least amount of energy possible in consideration of the environment

We will incorporate “heat value,” which is expanding and diversifying, and contribute to the future of society as a leading company that works to reduce fuel consumption to earn the trust of its customers while offering safe, comfortable heat management systems and components.

Yasuhiro Iida  
Head of Business Group

### Business Activities

- Development and production of air-conditioning systems for cars and buses, and cooling systems such as radiators

### Strengths

- Comprehensive capabilities for developing and producing car air-conditioning systems
- Ability to develop systems such as the world’s first heat pump system for the electrification of cars and cooling systems for power control units (PCUs)

### Main Products



HVAC units



Condensers



Radiators



Water-cooled intercoolers



Bus air-conditioners

### Business Strategy

#### Growth Targets

Drawing on our No. 1 share of clients around the world and our regional development capabilities, we will develop and introduce products that offer new value (with reduced fuel consumption, increased comfort, and comprehensive heat management) and work to expand sales of core products in emerging countries, such as car air-conditioners and radiators. By doing so, we will achieve stable growth that is parallel to the growth of the global automotive market.

#### Profitability

Through the introduction of world-first technologies and market-first products that offer new value, we create unique value for vehicles while enhancing our profitability. We also engage in rigorous efforts to reduce costs and transform our business portfolio, thereby strengthening the cost competitiveness of our core product lineups.

#### Differentiation

We will work to achieve differentiation by using our unique energy-conserving technologies to resolve internal combustion issues related to regulations on fuel economy and exhaust gas emissions. We will also pursue increased comfort focusing mainly on the five human senses and human biology research and work to systemize our air-conditioning products—for which we boast the No. 1 global share. In these ways, we will promote efforts to differentiate our existing products. Furthermore, in the field of electrified vehicles, we will steadily capitalize on growth in the market going forward by promptly introducing comprehensive heat management products.

#### Organizational Capabilities

We will carry out a full-scale shift from our core product fields to fields for products that offer new value. We will also undertake structural reforms to help us achieve our strategies through such means as strengthening collaboration on a global basis and utilizing business alliances.

Relevant Focus Fields

Electrification
Advanced Safety and Automated Driving
Connected Cars
Non-Automotive Businesses (FA and Agriculture)

Contribution to Long-term Policy (value of green and peace of mind)

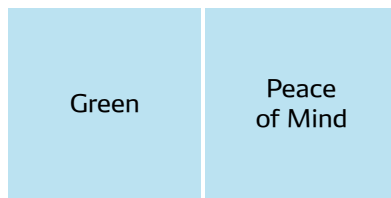

Relevant SDGs



Fiscal 2020 Results

Decrease in Revenue Due to COVID-19, Market Slowdowns, and Yen Appreciation

In fiscal 2020, revenue in the Thermal Systems Business declined 8.8% (5.3% on an actual basis that excludes foreign exchange rates and other factors) year on year, to ¥1,280.6 billion, due to the impact of the COVID-19 pandemic, market slowdowns, and yen appreciation.

Revenue (Billions of yen)



Resolving Social Issues through Our Businesses

Efforts toward Heat Management Products That Improve the Driving Distance of Electrified Vehicles and Efforts toward Creating Comfortable Vehicle Interiors

Some of the efforts aimed at popularizing electrified vehicles (xEVs) include improving driving distance and battery life and shortening the amount of time it takes to charge the battery. To achieve these efforts, it is important to control the energy consumption of these vehicles and keep xEVs' equipment such as batteries at an appropriate temperature. To that end, DENSO is leveraging the heat management technologies it has cultivated through its air-conditioning systems and heat exchangers to develop and commercialize heat pump systems for xEVs. These systems use outside air as a source for heating the interior of these vehicles, thereby reducing energy consumption. Furthermore, using heat management systems that utilize the heat created from the heat pumps, we are able to effectively control the temperature of the entire vehicle. With this technology, we aim to

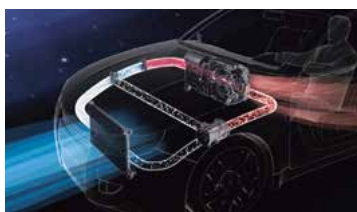

Heat pump system (rendered in-vehicle image)

improve driving distance by 25%, reducing charging time by one-third, and increase battery life by 20% with a view to popularizing xEVs and realizing a carbon-neutral society. Furthermore, in an effort to capture new user needs brought about by the CASE revolution, we will introduce products that offer comfort, such as air-conditioners that purify the air in vehicle interiors and ultra-small air-conditioning systems that help realize an expansive interior space. By doing so, we will contribute to the creation of safe and comfortable vehicle interiors.

Progress of Business Strategies Strengthening New Product Development by Shifting Our Focus to Growth Fields

By transitioning our business portfolio from existing products to growth fields, we are shifting our focus to heat management systems and products that offer new value such as comfort. For xEVs, our heat pump system with battery-operated cooling functions has been installed in the Toyota RAV4 PHV. By directly cooling the battery with an air-conditioning coolant, this heat pump system is able to maintain an adequate battery temperature. For products that offer comfort, we have introduced an air-conditioner with a system that can remove PM2.5 for the Toyota Corolla in China. Making use of a PM sensor, this air-conditioner can detect air pollution within the vehicle and increase the level of heating, ventilation, and air-conditioning (HVAC) in accordance with the level of air pollution detected. Using a filter, the air-conditioner swiftly removes PM2.5 and maintains a comfortable environment in the vehicle interior. At the same time, the level of pollution detected by the sensor is displayed within the vehicle, thereby visualizing air pollution that cannot be seen with the naked eye. We have also introduced an air-conditioner that includes a CN95 filter with enhanced performance in the Chinese market. Furthermore, in June 2020, we newly established the Air Quality Business Promotion Department and, through this office, we will accelerate efforts to strengthen the development of products that offer comfort going forward.



Air quality in China

Efforts toward Quality

Returning to our origins, we will promote the management of our businesses giving top priority to safety and quality. Specifically, we will enhance the degree of completeness in terms of our design quality by making full use of digital engineering. We will also improve the quality of our manufacturing by increasing the reliability of our manufacturing processes and efforts to address defects, in addition to improving the quality of our suppliers. Through these means, we will build a robust foundation of quality from the perspectives of both design and manufacturing.

# POWERTRAIN SYSTEMS



## Balancing the joy of life with vehicles with superior environmental performance—Providing solutions that help overcome this seemingly contradictory task

By reducing the environmental burden of vehicles to the greatest extent possible and pursuing both environmental and driving performance, we will support the development of internal combustion engines while supplying systems and components. By doing so, we will strive to create and deliver new value in order to contribute to society as a whole.

Katsuhisa Shimokawa  
Head of Business Group

### Business Activities

- Development and manufacture of gasoline and diesel engine management systems, which cover everything from combustion to intake and exhaust
- Development and manufacture of engine-related products, such as variable cam timing (VCT) systems and exhaust gas sensors; and products for drive systems, such as oil pressure control valves

### Strengths

- From the perspective of systems, we maintain and comprehensively develop a wide variety of technologies and are active across a broad range of business domains related to powertrains, extending from gasoline and diesel vehicles to hybrid and electric vehicles. We are also able to manufacture products in these domains using highly advanced production techniques.

### Main Products



Gasoline direct injector



High pressure pump



VCT



Exhaust gas sensor



Common rail systems



Spark plug

### Business Strategy

#### Growth Targets

In developed countries, we will promote efforts aimed at enhancing the efficiency of internal combustion engines in the age of electrification and developing new products that contribute to electrified vehicles and automated driving. Meanwhile, in emerging countries, we will realize optimized specifications using existing products and work to reduce costs. These efforts will in turn contribute to compact, inexpensive vehicles that are eco-friendly. Furthermore, by 2021 we will complete the development of technologies we originally intended to complete by 2025. By expanding our business in emerging markets and entering into new electrification domains, we aim to achieve stable annual growth.

#### Profitability

We will realize unbeatable levels of cost competitiveness in the expanding markets of emerging countries.

#### Differentiation

We will achieve superior environmental performance (reduced fuel consumption, emission control components) through innovative technologies. Leveraging our core technologies, we will allocate resources to the development of subsystems in new electrification domains.

#### Organizational Capabilities

We will pursue innovation in our development process, starting with model-based development that is able to conduct before-hand assessments via a simulation model rather than a trial product. We will also make full use of F-IoT to spur innovation in our production process. In these ways, we will enhance our system development capabilities and production technology capabilities, which are both Company strengths. By investing the resources we generate through these efforts in our core business fields, we will further improve the efficiency and speed of our management with the aim of achieving our business strategies.

### Relevant Focus Fields

<b>Electrification</b>
Advanced Safety and Automated Driving
Connected Cars
Non-Automotive Businesses (FA and Agriculture)

### Contribution to Long-term Policy (value of green and peace of mind)

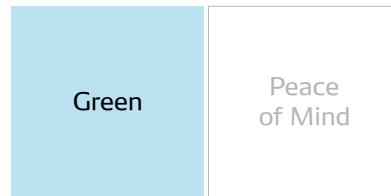

### Relevant SDGs



### Fiscal 2020 Results

#### Decline in Revenue Due to COVID-19, Market Slowdowns, and Yen Appreciation

In fiscal 2020, revenue in the Powertrain Systems Business declined 4.4% (2.8% on an actual basis that excludes foreign exchange rates and other factors) year on year, to ¥1,222.0 billion, owing to the impact of the COVID-19 pandemic, market slowdowns in Asia and Europe, and yen appreciation.

Revenue (Billions of yen)



### Progress of Business Strategies

#### Narrowing Down Development Themes and Accelerating Development Process Reforms

We are working to narrow down our development themes from the perspective of promoting the widespread adoption of electrification and pursuing joint development with car manufacturers. In these ways, we are making it possible to respond to a wide range of vehicles and regulations using the smallest product lineup possible.

In terms of the development process, we shared and utilized know-how via the Groupwide Design Engineering (DE) Promotion Conference to promote the thorough application of DE in component design and the automation of routine tasks. Going forward, we will draw on the resources generated through these efforts to transition into new domains both inside and outside the Powertrain Systems Business Group.

### Resolving Social Issues through Our Businesses

#### Development of Corrosion-Resistant Injectors Following Tighter Exhaust Gas Regulations

To respond to the increased application of exhaust gas recirculation (EGR)\*<sup>1</sup> that has followed the tightening of exhaust gas regulations, it has become necessary for nozzles that require micrometer-order precision to be resistant to corrosion. Through the world's first application\*<sup>2</sup> of the atomic layer deposition (ALD)\*<sup>3</sup> technique to create thin-film coating for fuel injector equipment, we have been able to improve the durability of such equipment and expand its EGR usage range. This in turn helps reduce NOx emissions and improve fuel performance. We believe this kind of coating technology can be applied as a fundamental technology for a carbon-free society.



\*1 Exhaust gas recirculation is a technique that allows a portion of exhaust gas to be recirculated back into the intake manifold.  
 \*2 Based on survey results as of 2019  
 \*3 Atomic layer deposition is a technique for forming single atomic layers and is used as a technology in the semiconductor field.



### Efforts toward Quality

We have positioned the restoration of our quality as our top priority issue and are working to build a corporate structure that prevents our products from causing quality-related issues in the market. To that end, we have established a new division specializing in quality, where we have gathered together human resources who can handle quality in a comprehensive manner, covering everything from systems to components. This division will engage in concerted efforts that span from investigating the true causes of quality-related issues to reproducing problems to determine a resolution. To respond to tightening regulations on fuel performance and exhaust gas as well as the increasing complexity of environmental stress, this division will accelerate and improve the accuracy of quality verification measures through DE and model-based development and virtual vehicle evaluations.

# ELECTRIFICATION SYSTEMS



## Supporting electrification in all areas of mobility to realize an enriched environment and the joy of driving

To deliver electrification systems for vehicles that are eco-friendly and enable even more comfortable travel, we have built up a solid track record with the development of electrification technologies, realizing high performance, compactness, and fuel efficiency for the major products needed for hybrid vehicles. Going forward, we will leverage our expansive business domains to form linkages between various in-vehicle systems and products in an effort to efficiently manage energy within vehicles. In this manner, we will further improve fuel efficiency and contribute to the conservation of energy.

Jiro Ebihara  
Head of Business Group

### Business Activities

- Development and manufacture of hybrid and electric car drive systems, power supply and related products, and power supply and starting system parts such as alternators and starters
- Development and manufacture of electric power steering motors, control brake motors, and electric control units (ECUs)
- Development and manufacture of various kinds of small motor system products, such as windshield wiper systems, power window motors, engine control motors, and blower fans

### Strengths

- Wide variety of technological know-how across a broad range of business domains that extend from internal combustion engine starting systems and power charging products to products powered by electricity such as hybrid cars, electric automobiles, and fuel-cell vehicles. Ability to draw on know-how and extensive business domains to engage in comprehensive, system-based development.

### Main Products



Power control unit



Motor generator



Battery ECU



Lithium-ion battery pack



Electric power steering motor



Control brakes (motor: ECU)



Windshield wiper system



Power window regulator motor

### Business Strategy

#### Growth Targets

As the leading supplier of energy management systems for electrified vehicles and electric drive systems that allow for superior control over driving, turning, and stopping, we will promote the electrification of a diverse range of mobility solutions, including not only automobiles but also aircraft, with the aim of realizing annual revenue growth of over 20%.

#### Profitability

Supported by the revenue generated by products for hybrid vehicles, which we have cultivated over the past 20 years, we will establish and leverage key technologies that can be applied to a wide range of mobility domains while working to enhance our product lineup. Also, in anticipation of the continued global increase in the number of electrified vehicles, we have established five production bases around the world, thereby globally promoting the electrification of a diverse range of mobility.

#### Differentiation

Utilizing in-house semiconductor manufacturing technologies and sophisticated winding technologies, we are boosting the competitiveness of our products in such ways as developing small, high-performance inverters and motors that help improve the fuel economy of vehicles. In addition, we have extremely thorough knowledge of the characteristics of automobiles. Using the technologies we possess, we will improve the value of vehicles as a whole, from components to systems.

#### Organizational Capabilities

In 2018, we integrated the small motor business (formerly ASMO Co., Ltd.) with the steering and braking systems business (internal organization). In 2019, we commenced collaboration with AISIN AW CO., LTD. and a company in China to expand on these efforts. Furthermore, from April 2020 we integrated the core electronic component business of Toyota Motor Corporation into the Company and commenced operations of this business at our Hirose Plant. In these ways, we have put in place a structure for promoting the development of sophisticated system products that offer high added value.

## Relevant Focus Fields

Electrification
Advanced Safety and Automated Driving
Connected Cars
Non-Automotive Businesses (FA and Agriculture)

Contribution to Long-term Policy  
(value of green and peace of mind)

Green	Peace of Mind
-------	---------------

## Relevant SDGs



## Fiscal 2020 Results

## Increase in Revenue on an Actual Basis Due to the Steady Expansion in Products Powered by Electricity

In fiscal 2020, revenue in the Electrification Systems Business rose on an actual basis due to the increased production of power controller units for Toyota vehicles, which help offset the market slowdown owing in part to the impact of the COVID-19 pandemic. However, due to the impact of yen appreciation, revenue declined 1.5% year on year (increased 0.5% on an actual basis), to ¥897.4 billion.

Revenue (Billions of yen)



## Progress of Business Strategies

## Strengthening Organizational Capabilities to Popularize Electrification

Amid the progressing shift toward electronic control of automotive components, the importance of the electronic component business will become even greater going forward. We integrated our major electric component divisions with those of Toyota Motor Corporation. Operations of this new electronic component business commenced at the new DENSO Hirose Plant (formerly Toyota Hirose Plant) in April 2020, together with development and production operations. In addition, we joined forces with Aisin Seiki Co., Ltd. to establish BluE Nexus Corporation in April 2019, a joint venture company that develops and sells driving module packages that consist of the key components needed for electrified vehicles. Through a product lineup that meets a wide range of electrification needs and a development and sales structure that can deliver the necessary performance and adapt and respond to local circumstances, BluE Nexus will aim to promote the popularization of electrification across the globe.

To serve as an electrification headquarters that helps us build a development structure for the future, we established the

Electrification Innovation Center (EIC) at our Anjo Plant in June 2020. The EIC houses product development and production functions that enable us to establish a speedy and competitive structure for development and production and maximize our resources. Furthermore, through the EIC, we will strive to enhance our Groupwide profitability and achieve differentiation. We will also work to create attractive products and promote *Monozukuri* that offers peace of mind and creates inspiration. In this manner, we will realize co-creation with the local community.



Electrification Innovation Center (Anjo Plant)

Resolving Social Issues through Our Businesses  
Developing Safe and Secure Electric Power Steering That Reduces the Burden on the Environment

DENSO has developed and is working to commercialize a new Electric Power Steering Motor Control Unit (EPS-MCU), which assists handling using the power of a motor. By transitioning from hydraulic power steering, which uses engine power, to electric, the EPS-MCU helps conserve both fuel and resources. In 2015, we led the world in the development of an EPS-MCU called DENSO Dual Assist 1st Generation (DDA1). The DDA1 supports the power steering unit with two systems, one acting as a backup that assists with handling in case a problem occurs. In addition, the DDA1 helps contribute to automated driving, which will become widespread in the future.

The newly developed EPS-MCU, called DENSO Dual Assist 2nd Generation (DDA2), represents the evolution of the DDA1 and has achieved a 10% reduction in size, as well as lower noise. The DDA2 is featured in the TOYOTA 2020 Harrier, which was launched in June 2020. Going forward, we will continue to contribute to the electrification of mobility that offers safety and security to people around the world.

Relevant  
SDGs

DDA2

## Efforts toward Quality

Inheriting the trust-oriented mindset that DENSO has long cultivated, we have established numerous conditions for creating quality products taking into account the various market environments and users around the world. Based on these conditions, we are utilizing digital tools to offer product lineups featuring not only our core designs but also designs customized to meet the needs of our customers. At the same time, we are taking steps to standardize our designs so that our products can continue to be used by customers in a safe and secure manner. In this business group, we view quality as the true source of DENSO's competitiveness and, through these activities, we are working to further enhance our quality.

# MOBILITY ELECTRONICS



## Realizing a society in which all people can move comfortably and with peace of mind (Quality of Mobility)

By combining advancements from the perspective of integrated systems, including sensors, semiconductors, ECUs, and platforms, and developments from the perspective of vehicles and end-users, we will pursue new value in the form of eliminating traffic accidents and traffic congestion. Through these efforts, we will contribute to the realization of a society in which all people can move comfortably and with peace of mind (Quality of Mobility).

Hirotsugu Takeuchi  
Head of Business Group

### Business Activities

- Development and provision of electronic systems, services, and platforms that support all aspects of mobility
- Development and manufacture of cockpit products such as human-machine interface (HMI) control units, meters, head-up displays (HUDs), air-conditioning panels, and driver status monitors (DSMs).
- Development and manufacture of connected products and services, including telematics control units (TCUs), electronic toll collection (ETC) 2.0 on-board devices, and road-to-vehicle and vehicle-to-vehicle communication devices
- Development and manufacture of autonomous driving (AD) and advanced driver assistance system (ADAS)-related products, such as vision sensors, millimeter-wave radar sensors, sonar sensors, driving-support electronic control units (ECUs), and sensors and ECUs for airbags
- Development and manufacture of electronics products, including powertrain ECUs and body ECUs
- Planning and development of retrofitted products such as acceleration control devices for when drivers accidentally step on the gas pedal

### Strengths

- Broad range of technologies, including road environment recognition, HMI, connected technologies, and powertrain ECUs. Ability to undertake the development of products that draw on the competitive strengths of these technologies
- Ability to develop products with outstanding levels of reliability and security by melding the unique value and performance of in-vehicle products with IT products

### Main Products



Vision sensors



Millimeter-wave radar sensors



Powertrain ECUs



DSMs



Combination meters



TCUs

### Business Strategy

#### Growth Targets

We will boost sales through the introduction of highly competitive, next-generation products with the aim of capitalizing on growth in the automated driving and connected car markets. In addition, with the progression of connected technologies, we will expand our business in not only the in-car domain but also the out-car domain and new domains that connect in-car and out-car domains. Through these efforts, we will realize growth that surpasses our Companywide sales growth targets.

#### Profitability

To address the increase in the number of man-hours to develop software brought about by the increase in the size of systems, we will work to enhance the efficiency of our platform development, thereby boosting our profitability.

#### Differentiation

We will offer new products that leverage such strengths as our collaborative development of extensive technologies in the in-car domain, such as road environment recognition, HMI, connected technologies, and powertrain ECUs, as well as the unique quality and performance of our in-vehicle products, which we cultivated over many years in various domains, including the out-car domain.

#### Organizational Capabilities

To respond to the rapid evolution of automated driving and connected cars, we will carry out a full-scale in-house shift toward these technologies and recruit human resources specializing in IT. Additionally, we will actively pursue alliances with optimal partners and work to secure the necessary technologies and talent. In these ways, we will strengthen and accelerate our development capabilities.



## Relevant Focus Fields

Electrification
Advanced Safety and Automated Driving
Connected Cars
Non-Automotive Businesses (FA and Agriculture)

Contribution to Long-term Policy  
(value of green and peace of mind)

Green	Peace of Mind
-------	---------------

## Relevant SDGs



## Fiscal 2020 Results

## Increase in Revenue Due to the Rising Installation Rate of Accident Prevention and Safety Products

In fiscal 2020, revenue in the Mobility Electronics business increased 0.2% (2.1% on an actual basis that excludes foreign exchange rates and other factors) year on year, to ¥1,112.6 billion, despite such factors as market slowdowns due to the COVID-19 pandemic and yen appreciation.

Revenue (Billions of yen)

FY2020	1,112.6
FY2019	1,110.9

## Progress of Business Strategies

## Strengthening Competitiveness and Accelerating Commercialization in New Domains by Streamlining Development Functions to Respond to the Advancement of the CASE Revolution

With the aim of further enhancing our speed and strengthening our competitiveness by streamlining our electronics and software development functions, we integrated the ECU and fundamental technology development functions of the Electronic Systems Business Group with the Mobility Systems Business Group in July 2019, thereby establishing the new Mobility Electronics Business Group.

Furthermore, in January 2020 we streamlined technological development functions within the Mobility Electronics Business Group to establish the Connected Systems Business Development Division. This office aims to accelerate the commercialization of our connected systems.

We also developed various new products in fiscal 2020 with a view to achieving our growth targets. These included Paak (Phone-as-a-Key), a world-first technology that uses smartphones as a vehicle key, and sophisticated parking assistance systems that automatically control not only steering but also speed.

## Resolving Social Issues through Our Businesses

## Launching Harmony Core™ Integrated Cockpit System—World's First Installation of QNX® Hypervisor in Vehicles

By linking numerous HMI products, we developed Harmony Core™, an integrated cockpit system that improves driver convenience. This product has been installed in the all-new 2020 Subaru Legacy and Outback (U.S. model), which was launched in fall 2019. In addition, BlackBerry QNX® Hypervisor technology has been installed in the newly developed Harmony Core™ integrated cockpit system, making it the world's first product to feature this technology.

In recent years, the amount of information provided by a vehicle to the driver has increased due to advanced driver assistance functions using cameras and sensors, as well as entertainment functions that link smartphones with automobiles. Accordingly, vehicle interiors are now equipped with numerous HMI devices, such as meters and car navigation systems, making it necessary to have device-specific operating systems (OS) and microcomputers. For example, a highly reliable OS is required to control meters related to safety. Meanwhile, an OS with high versatility is required to link cars with smartphones. Harmony Core™ is able to control multiple HMI devices with different OS using one microcomputer. By doing so, Harmony Core™ forms seamless connections between these devices, thereby enhancing the level of safety and convenience for customers.

Note: QNX is a registered trademark of BlackBerry Limited.



Subaru Legacy and Outback (U.S. model)  
(Image provided by SUBARU CORPORATION)

## Relevant SDGs



## Efforts toward Quality

Software development for in-vehicle products is becoming more expansive and sophisticated following the advancement of the CASE revolution. Under these circumstances, we aim to realize a more robust quality control structure by leveraging synergies within the Mobility Systems Business Group, which has streamlined our electronics and software development functions. Based on an approach that prioritizes safety and quality above all else, we will make Groupwide efforts to prevent the recurrence of quality-related issues.

# SENSORS & SEMICONDUCTORS



## Leading the industry with semiconductor and sensing technologies with a view to realizing an eco-friendly, comfortable, and safe mobility society

We will streamline and thoroughly enhance our technological development of semiconductors (brain) and sensors (eyes) across all our major businesses in an effort to support innovation in automobiles. In addition, through the development of electronic elemental technologies that offer value optimized for the new mobility society, we will reduce environmental burden and contribute to the realization of a society in which people can move safely and with peace of mind.

Hiroyuki Ina  
Head of Business Group

### Business Activities

- Development and manufacture of microelectronic devices, such as in-vehicle power semiconductors, semiconductor sensors, and integrated circuits (ICs).

### Strengths

- Extensive product lineup that spans from sensors to power modules and development capabilities for elemental technologies
- Advanced technological strengths capable of in-house semiconductor manufacturing
- Development capabilities in the vertical integration of semiconductors\* that satisfy needs for sophisticated and compact system products

\* DENSO proprietary integrated semiconductor development, from semiconductors to ECUs and actuators

### Main Products

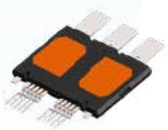

Power cards



Semiconductor sensors



Application Specific Integrated Circuit (ASIC)

### Business Strategy

#### Growth Targets

In addition to our combustion-based businesses, we will promote businesses related to electrification, advanced safety, and automated driving. To support such businesses, we will develop products that anticipate the needs of car manufacturers and the automobile market. Furthermore, we will thoroughly enhance the competitiveness of our semiconductor and sensor technologies, which provide us with the source for realizing differentiation. Through these efforts, we will realize sustainable growth and establish a competitive position in the in-car electronics field.

#### Profitability

Rather than promote development for each vehicle on an individual basis, we will clarify standardized platforms (core domains) and variation development (customized domains). By doing so, we will increase the efficiency of our development efforts and expand our product lineups.

#### Differentiation

To respond to the evolution of systems, we will help clients realize their aspirations through value-added semiconductors and deliver technologies and products that can be put to use in various systems and in society at large. To that end, we will continue to create elemental technologies, starting with technologies for the semiconductor development process, that will serve as the source of our differentiation.

#### Organizational Capabilities

We will dramatically improve development processes, enhance efficiency, and accelerate management.

## Relevant Focus Fields

Electrification
Advanced Safety and Automated Driving
Connected Cars
Non-Automotive Businesses (FA and Agriculture)

Contribution to Long-term Policy  
(value of green and peace of mind)

Green	Peace of Mind
-------	---------------

## Relevant SDGs



## Fiscal 2020 Results

Decline in Revenue Due to COVID-19,  
Market Slowdowns, and Yen Appreciation

In fiscal 2020, revenue in the Sensors & Semiconductors Business declined 3.6% (2.2% on an actual basis that excludes foreign exchange rates and other factors) year on year, to ¥139.2 billion, owing to the impact of the COVID-19 pandemic, market slowdowns, and yen appreciation.

Revenue (Billions of yen)

FY2020	139.2
FY2019	144.4

## Progress of Business Strategies

Strengthening Diverse Partnerships, Streamlining  
In-House Organizations, and Accelerating the  
Speed of Development and Management

In order to enhance the effects of streamlining semiconductor and sensor technology development within the Company, thereby strengthening competitiveness of these technologies, we established the Sensor & Semiconductor Business Group as an independent business group in July 2019. In this business group, we have created a two-business structure that separates sensors and semiconductors into individual businesses, as the issues and external environment that face these technologies differ. By doing so, we have further clarified the issues to address in each business and are promptly moving forward with the formulation and execution of relevant business strategies. For example, based on the "home & away strategy" of the Toyota Group, we streamlined operations at the Toyota Hirose Plant (now DENSO's semiconductor plant) in an effort to establish a speedy and competitive structure for development and production and strengthen our overall development of products powered by electricity.

## Resolving Social Issues through Our Businesses

Developing a Lithium Battery Monitoring Unit with IC for  
Electrified Vehicles That Realizes World-Class Accuracy  
and Multi-Cell Monitoring

Through a unique wafer process, we developed and realized the mass production of a battery monitoring unit (BMU) with an integrated circuit (IC) for lithium-ion batteries that realizes world-class accuracy and multi-cell monitoring. Through highly accurate measurements of battery capacity, this BMU ensures that batteries are used to their full capacity, thereby significantly increasing the driving distance of electrified vehicles (xEVs). Also, with multi-cell monitoring, the number of individual ICs can be reduced to create more compact battery systems and reduce costs. Through the development of this BMU, we are promoting the widespread adoption of lithium batteries in cars and boosting the percentage of xEVs in the market. In this way, we are helping to conserve the environment and realize a green mobility society.

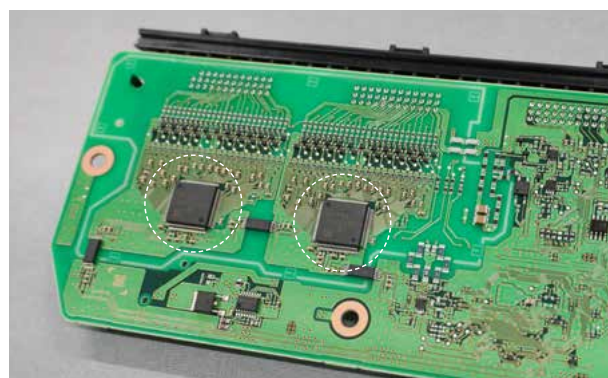
Relevant  
SDGs

Lithium battery monitoring unit with an integrated circuit

## Efforts toward Quality

We produce over 900 million IC chips in-house a year. As these IC chips are used in a wide range of products, it is imperative that we promote measures from a long-term perspective to prevent the occurrence of defects. To that end, we must fundamentally resolve the issues that led to the occurrence of the quality-related issue. We have established a specialized team for tackling problems on the manufacturing front lines and, centered on this team, we are making comprehensive efforts to address the sources of manufacturing-related issues with the aim of assuring quality.

## NON-AUTOMOTIVE BUSINESSES: FA



### Enhancing the productivity of the manufacturing industry and contributing to an improved quality of life with a commitment to our long-cultivated technologies

DENSO has a solid track record of introducing factory automation (FA) systems in 130 factories on a global basis. Leveraging this record, we will propose and provide FA systems that can meet the diverse needs of our customers. We offer solutions packages that include lean automation, which draws on the process design and know-how of frontline management that we have cultivated over many years through the manufacture of automotive components. In addition to process automation that leverages robots, QR codes and bar codes, and radio frequency identification (RFID),\* these solutions packages provide features for supporting operational improvements through the use of IoT. Through these solutions packages, we will make extensive contributions to the development of the manufacturing industry.

Shinya Sugiura  
Head of FA Business Unit

\* RFID is a non-contact scanning system that uses radio waves to identify and track numerous tags attached to objects

### Business Activities

- Development and manufacture of industrial equipment best exemplified by our automated equipment, modules, and industrial-use robots
- Development and manufacture of equipment for use by society, including handy terminals and QR and RFID payment and recognition solutions, and provision of services

### Strengths

- Integration of technologies accumulated in the automotive field and unique technologies created in non-automotive fields

### Main Products



Automated modules



Vertical articulated robots



Collaborative robots



IoT data servers



Barcode and 2D code handy terminals



QR solution services

### Business Strategy

#### Growth Targets

We will commercialize lean automation in an effort to establish it as a business pillar in the non-mobility field.

#### Profitability

Throughout society, we provide flexible, waste-eliminating lean automation created from our long-cultivated *Monozukuri* experience and techniques. In accordance with customers' needs, we provide solutions packages by process and module rather than by individual equipment in a wide range of domains. By doing so, we aim to realize further business expansion.

#### Differentiation

By melding the automated technologies and improvement know-how of DENSO CORPORATION, the "user," with the core technologies of Denso Wave Inc., the "manufacturer," including robots, sensor verification systems, and QR codes, we will provide FA system products that can only be proposed through the unique perspectives of two DENSO companies. These FA system products will cater to the frontline operations of our customers.

#### Organizational Capabilities

In May 2018, we established the internal Denso Wave Kariya Office, thereby strengthening collaborative development between DENSO's FA Business Unit and Denso Wave's Robot Business Unit. Going forward, we will deepen our collaboration with external partners that share the same desire to promote the widespread use of lean automation as we work to spur industrial innovation.

## Relevant Focus Fields

Electrification
Advanced Safety and Automated Driving
Connected Cars
Non-Automotive Businesses (FA and Agriculture)

## Contribution to Long-term Policy (value of green and peace of mind)

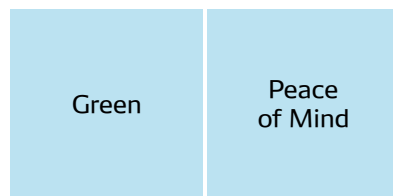

## Relevant SDGs



## Progress of Business Strategies

## Presenting the New Robot Control RC9—Expanding Our Lineup of Vertical Articulated Robots

At International Robot Exhibition 2019, which was held at Tokyo Big Sight in December 2019, we presented the new robot controller RC9, as well as the VM Series (payload: 25 kg) and VL Series (payload: 40 kg), which are a new lineup of DENSO's vertical articulated robots. In August 2020, we commenced the sale of these new products.

In addition to enhancing our lineup of robots with a long reach and high payloads, the new robot controller RC9 is the first robot controller in the industry that offers not only hardware but also firmware.\* With the RC9, our customers can choose the optimal robot, peripheral equipment, and software in accordance with specific applications. Accordingly, the RC9 is able to establish optimized robot systems that can meet the needs of each individual customer.

\* Software for controlling computer systems (hardware)



VM Series (left) and VL Series (right)

Resolving Social Issues through Our Businesses  
Improving Productivity in the Monozukuri Industry through FA System Products

The *Monozukuri* industry is facing global issues such as a declining workforce and higher labor costs in emerging nations. In light of these issues, the industry is entering into a major period of change. As a means to resolve the issue of labor shortages and reduce labor costs, we are providing highly efficient FA system products that thoroughly eliminate wasteful procedures, thereby aiming to improve the overall productivity of the *Monozukuri* industry.

In December 2019, we presented our D Series at International Robot Exhibition 2019. The D Series is a solution for process rationalization that draws on our core technologies, including automation, robots, and sensors. We plan to commence the sale of the D Series during fiscal 2021 as a proposal for new solutions in fields that require extensive manpower, such as assembly, inspection, and logistics.

## Relevant SDGs



D Series process rationalization solution

## Efforts toward Quality

In the automotive component business, DENSO has worked to establish the optimal quality assurance structure in accordance with the evolution of technology. Through this structure, DENSO has taken steps to create products that place top priority on safety. Going forward, we will make proposals for FA systems that leverage the quality and safety initiatives we have thoroughly refined through our on-site manufacturing operations at our 130 factories across the globe. With these proposals, we will make contributions to the overall manufacturing industry.

# NON-AUTOMOTIVE BUSINESSES: AGRICULTURE



## Combining technologies and ideas to contribute to an enriched society where all people can live safely and with peace of mind

Food is essential to human life. Together with our business partners, we will integrate the technologies for industrialization that we have cultivated in the automotive field to provide new value to the entire food value chain and deliver peace of mind and security with regard to food.

Hidehiro Yokoo  
Head of Food Value Chain Business Development Division

### Business Activities

- Development, manufacture, and sale of solutions for horticultural facilities (consulting and cloud services related to greenhouse materials, devices, and cultivation) as well as the provision of after-sale services
- Development and manufacture of in-vehicle refrigeration units

### Strengths

- Provision of proposal-based solutions that closely address agricultural producers' needs and issues
- Development of cold chain products that meet a broad range of needs related to food delivery

### Main Products



Horticultural facilities (consulting and cloud services related to greenhouse materials, devices, and cultivation)



Environmental control systems for greenhouse cultivation, *Profarm-Controller*



Semi-closed greenhouse, *Profarm T-cube*



In-vehicle refrigeration units

### Business Strategy

#### Growth Targets

We will offer environment control technologies for greenhouse cultivation, which we have developed in the agricultural field, and in-vehicle refrigeration units, which we sell in the logistics field. In addition, we will pursue industry-government-academia partnerships to provide new value to the overall food value chain through our technologies for industrialization, while at the same time working to integrate technologies such as QR codes, which are used widely in the logistics field.

#### Profitability

We operate solutions businesses for horticultural facilities not only in Japan but also in regions such as Asia, where populations are increasing. Furthermore, we promote the development of new products in our lineup of in-vehicle refrigeration units, thereby creating and offering new value within the cold chain.

#### Differentiation

By accurately addressing needs and issues in all areas of the food value chain and providing comprehensive solutions accordingly, we will work to resolve food-related issues together with our business partners.

#### Organizational Capabilities

In April 2020, we established the Food Value Chain Business Development Division, which promotes comprehensive efforts that cover everything from agricultural production to logistics and consumption. Furthermore, in March 2020 we invested in Certhon Group and, together with Certhon, we established DENSO AgriTech Solutions, Inc. in May 2020. Through these kinds of efforts, we will continue to lead the way with innovations in the industry through our business partnerships and alliances.

Relevant Focus Fields

Electrification
Advanced Safety and Automated Driving
Connected Cars
Non-Automotive Businesses (FA and Agriculture)

Contribution to Long-term Policy (value of green and peace of mind)

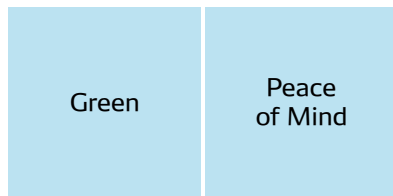

Relevant SDGs



Progress of Business Strategies

Establishing a Structure for the Global Expansion of Solutions for Horticultural Facilities

To globally expand our solutions for horticultural facilities, we invested in the Dutch company Certhon Group, which sells large-scale greenhouse solutions using world-class advanced technologies to more than 20 countries around the world, in March 2020.

By combining Certhon's advanced technologies in Europe with our extensive technologies in the automotive field, we will promote the development of next-generation products for horticultural facilities in accordance with the diverse needs of each country and region across the globe.

Furthermore, in May 2020 we established DENSO AgriTech Solutions, Inc. together with Certhon. This company has commenced sales of solutions that combine the respective know-how and products of DENSO and Certhon.



Resolving Social Issues through Our Businesses

Creating Models for Horticultural Facilities That Resolve Issues in the Agricultural and Food Industries

As a means for resolving global social issues such as ensuring a stable food supply and addressing the declining agricultural workforce, we aim to create agricultural production systems (smart agriculture) that leverage robotic technologies and ICT and establish farmer-friendly working environments.

At AgriD Inc., which was established with Asai Nursery, Inc. in 2018, we commenced the mass production and sale of tomatoes in March 2020. Through the introduction of such technologies as industrial process design and on-site management systems, automated harvesting robots, and automated transport robots, we are working to demonstrate the capabilities of new agricultural production systems. With these efforts, not only are we pursuing high levels of productivity, we are also reducing the amount of heavy labor done by people. By doing so, we are realizing work environments that make it easier for women, the elderly, and people with disabilities. In this manner, we will help resolve the social issues of a declining agricultural workforce going forward.

Relevant SDGs



Rendering of a large-scale greenhouse at AgriD  
Location: Inabe City, Mie Prefecture; Scale: 4ha (cultivation area)



Cherry tomatoes harvested by an automated harvesting robot

Efforts toward Quality

We will realize optimized levels of quality and service in the field of next-generation horticultural facilities, drawing on the quality control methods that we have cultivated for many years in the automotive field.

In addition, with the aim of providing food that is safer and more secure throughout the entire food value chain, we will collaborate with external companies within all processes from food production to consumption to establish the necessary quality control methods for maximizing the value we offer to customers.

# 4 Corporate Governance

- 79 Corporate Governance
- 86 Dialogue with the Outside Directors
- 90 Directors and Audit & Supervisory Board Members
- 92 Risk Management
  - 92 CRO Message
- 94 Compliance





# Corporate Governance

## Basic Stance

The automotive industry is said to be facing a once-in-a-century paradigm shift. DENSO recognizes the establishment of corporate governance as a priority initiative for overcoming the challenges of the times and achieving sustainable long-term increases in corporate performance in a fast-changing global market. Based on its Basic Policies on Corporate Governance, DENSO has adopted a corporate auditor system under which it has established the General Meeting of Shareholders, Board of Directors, Audit & Supervisory Board, and Accounting Auditors as statutory bodies. In addition to these legal functions, the Company has established various governance-related frameworks. At the same time, the Company provides information regarding its business conditions to its shareholders and other investors on an ongoing basis, thereby implementing sound, efficient, and transparent management.



Basic Policies on Corporate Governance:  
<https://www.denso.com/global/en/-/media/global/about-us/sustainability/governance/management/management-doc-corporate-governance-policy-2019-en.pdf>



## Efforts to Improve Corporate Governance

DENSO is working to evolve its corporate governance to realize sustainable increases in corporate value even amid a dramatically changing world. To that end, we have been reducing our number of officers on a yearly basis to not only enhance discussion on Companywide strategies but also increase the speed of management decision-making and execution. In fiscal 2020, in addition to significantly reducing the number of officers, we clearly separated the roles of our senior executive officers and executive officers. Furthermore, we have been making efforts to improve the effectiveness of the Board of Directors. These include appointing officers with a higher awareness of gender distinction and internationality. These also include the introduction of a restricted stock compensation plan for members of the Board in fiscal 2021.

Going forward, we will continue to implement sound, efficient, and transparent management including through the significant reduction of cross-shareholdings.

## Change in Corporate Governance Structure

(Fiscal year)

	2015	2016	2017	2018	2019	2020	2021	
Number of officers	52	50	51	53	56	28	<b>27</b>	
Number of members of the Board	14	13	13	9	7	8	<b>8</b>	
Number of outside directors	2	2	2	2	2	3	<b>3</b>	
Number of female directors						1	<b>1</b>	
Number of Audit & Supervisory Board members	5	5	5	5	5	4	<b>4</b>	
Number of outside Audit & Supervisory Board members	3	3	3	3	3	2	<b>2</b>	
Number of female Audit & Supervisory Board members						1	<b>1</b>	
Basic Policies on Corporate Governance		June 2015 Formulated						
Separation of management and execution	June 2014					April 2019		
	<ul style="list-style-type: none"> <li>Separated and clarified the roles between members of the Board, who are responsible for management (decision-making and supervision), and senior executive directors (newly established position) and executive directors, who are responsible for the execution of business operations</li> <li>Appointed outside directors</li> </ul>					<ul style="list-style-type: none"> <li>Changed title of "senior executive director" to "senior executive officer"</li> <li>Changed title of "executive director" to "executive officer"</li> </ul>		
			June 2016				January 2020	
		<ul style="list-style-type: none"> <li>Established the Officer Nomination and Compensation Advisory Council, comprising independent outside directors, as an ad-hoc committee that corresponds to the Nomination Committee and the Compensation Committee</li> </ul>				<ul style="list-style-type: none"> <li>Appointed independent outside director as the chair of the Officer Nomination and Compensation Advisory Council</li> </ul>		
				April 2017				
				<ul style="list-style-type: none"> <li>Reduced the number of appointed members of the Board</li> <li>Changed the timing of appointment of officers from the date of the General Meeting of Shareholders in June to April, which is the beginning of the fiscal year</li> </ul>				
Improvement of effectiveness			June 2016					
			<ul style="list-style-type: none"> <li>Held annual interviews with those attending meetings of the Board of Directors to examine issues and measures for improvement (The results for interviews held in fiscal 2016 were announced in fiscal 2017.)</li> </ul>					
						June 2020		
						Revised compensation for Board members 1. Reviewed total compensation amounts 2. Introduced restricted stock compensation plan		

## Corporate Governance System

### Corporate Governance System and Principal Organizations

DENSO has adopted a corporate auditor system under which it has established the General Meeting of Shareholders, Board of Directors, Audit & Supervisory Board, and Accounting Auditors as statutory bodies. Through a corporate officer system that separates and clarifies the roles between members of the Board, who are responsible for management (decision-making and supervision), and executive vice presidents and senior executive officers, who are responsible for the execution of business operations, DENSO CORPORATION is streamlining the number of members of the Board and is realizing swift decision-making and business operations.

Under this system, depending on the circumstances, members of the Board serve concurrently as executive vice presidents and senior executive officers to ensure that the Board maintains an overall balance of knowledge, experience, and ability. DENSO CORPORATION sets the term of

office for members of the Board at one year, with the aim of building a flexible management structure that responds to changes in the management environment and further clarifying management responsibility during the business year.

### Reason for Selecting Our Current Corporate Governance System

In addition to performing management decision-making that emphasizes *genchi genbutsu* (on-site verification), DENSO believes that it is important to build a system that can verify whether management decision-making has met shareholder expectations and whether there is a problem from the point of view of governance. Accordingly, we believe that the current system to supervise and audit the execution of business duties by the Board of Directors including outside directors, as well as Audit & Supervisory Board members including outside Audit & Supervisory Board members, is most suitable.

### Corporate Governance System

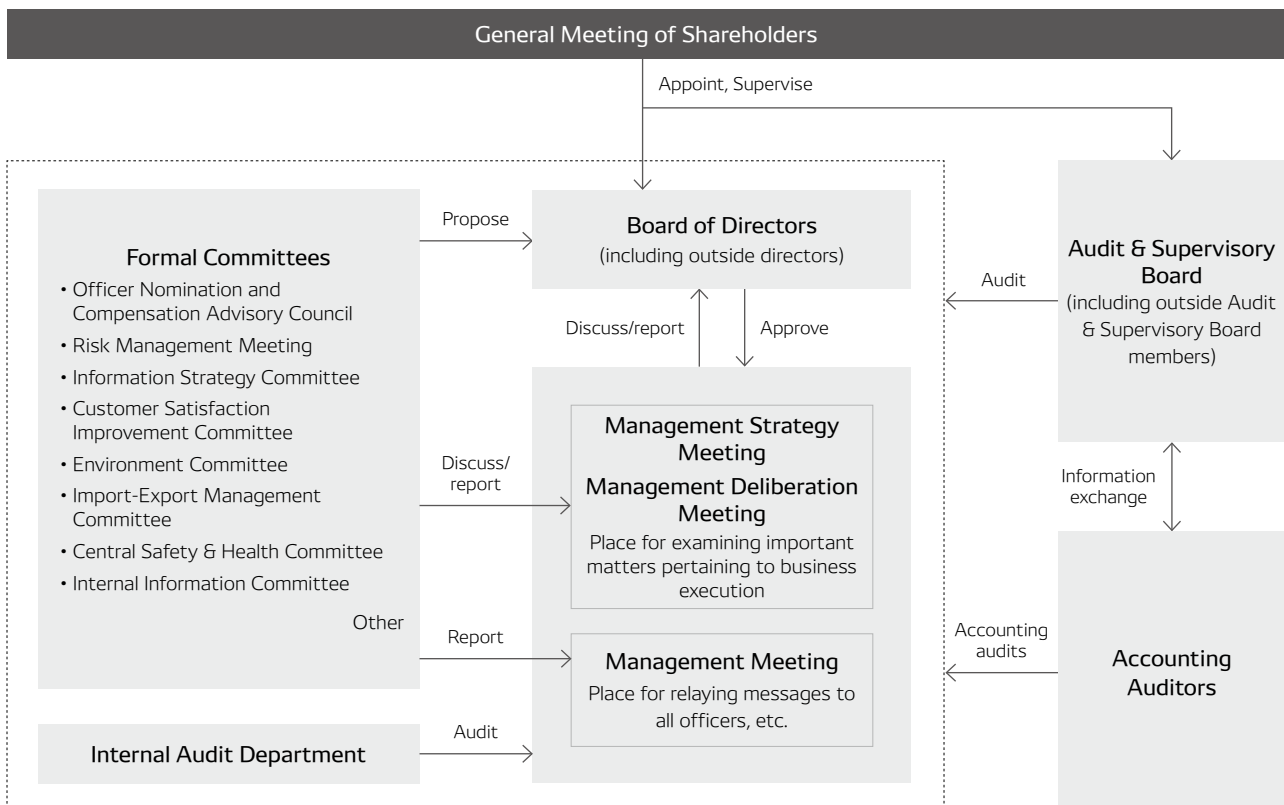

### Board of Directors

The Board of Directors resolves matters stipulated by laws and regulations, as well as matters of importance to the Company's decision-making. Where possible, the Board delegates authority to those in charge of business execution. This approach simultaneously accelerates execution and enables the Board to spend more time deliberating on management policies and strategies.

The Board of Directors meets once a month, in principle, and is composed of 12 members: eight directors (including three outside directors), two inside Audit & Supervisory Board members, and two outside Audit & Supervisory Board members. With respect to the independence of outside directors and outside Audit & Supervisory Board members, the Company has selected a total of five independent officers (three outside directors and two outside Audit & Supervisory Board members) based on the assumption that they fulfill the independence criteria stipulated by the Financial Instruments and Exchange Act.

Resolutions must be approved by a majority of the members present at a Board of Directors' meeting, and the meeting itself must be attended by a majority of directors. We have been enhancing our support structure for the outside directors to ensure the productive and efficient operation of the Board of Directors when making resolutions.

### Results of Board Meetings Held in Fiscal 2020

Number of meetings held	14
Attendance rate	Directors: 98% Audit & Supervisory Board members: 100%

### Support Structure for Outside Officers

When holding Board meetings, we provide outside directors and outside Audit & Supervisory Board members with preliminary explanations on important agenda items before the meetings with the aim of ensuring access to information between the inside and outside officers and maximizing the performance of our outside officers. In this way, we make concerted efforts to ensure the efficient operation of Board meetings. Furthermore, we plan and conduct on-site visits to facilities for outside officers so that they can deepen their understanding regarding the details of our businesses and the status of our frontline operations.

In addition, we have established the Audit & Supervisory Board Office as an organization dedicated to supporting the Audit & Supervisory Board members in conducting their duties. The office reports the condition of audits at liaison meetings and other meetings of the Audit & Supervisory Board. Additionally, we hold meetings twice a year between the Audit & Supervisory Board members and the outside directors to exchange opinions, in addition to regular meetings of the Independent Officer Meeting. Through these means, we are striving to actively provide information to our outside officers as well as invigorate communication between them.

### Structure for Business Execution

DENSO CORPORATION separates the functions of the Board of Directors, which conducts management oversight, and the executive directors, who handle business execution.

As bodies for deliberating important matters pertaining to business execution, the Company has established the Management Strategy Meeting and the Management Deliberation Meeting. The Company has also established the Management Meeting as a body for facilitating communication. These three bodies, together with the Board of Directors, are positioned as executive committees.

### Overview of Deliberating Bodies on Business Execution

	Deliberating body		
	Management Strategy Meeting	Management Deliberation Meeting	Management Meeting
Chairperson	President	President	President
Composition	President, executive vice presidents, the heads of each business group and functional department, general managers, and inside Audit & Supervisory Board members	President, executive vice presidents, the heads of each business group and functional department, general managers, and inside Audit & Supervisory Board members	President, executive vice presidents, senior executive officers, executive officers, and inside Audit & Supervisory Board members
Purpose	Deliberate on important items related to the Company's overall management (Companywide business plans, investment projects, important transactions, collaborative projects, other important management-related matters), starting with the agenda items at meetings of the Board of Directors	Hold strategic discussions, particularly from a medium- to long-term perspective, focused on businesses, functions, and regions	Share information related to business execution with officers throughout the Company, including matters for resolution by the Board of Directors and matters for deliberation by the Management Deliberation Meeting. Communicate and report information on projects that require swift action
Number of meetings held in fiscal 2020	14	34	Once a month, in principle

## Management Oversight Function

Two inside Audit & Supervisory Board members and two outside Audit & Supervisory Board members with dedicated staff are responsible for monitoring the execution of duties by directors as well as the business operations and financial conditions of the Group.

In accordance with in-house regulations, the Internal Audit Department conducts internal audits on the legality, validity, and efficiency of the Company's operations. Based on the issues pointed out in these audits, each department

of the Company is working to establish and subsequently enhance operational control and management systems. Audit & Supervisory Board members attend important meetings including meetings of the Board of Directors and audit directors' execution of their business duties through the exchange of information with the Internal Audit Department and internal control-related departments, as well as with the Accounting Auditors, thereby fulfilling their management oversight function.

## Policy and Procedures for the Appointment of Directors and Audit & Supervisory Board Members

Policy	Without consideration of gender or age, nominate directors and Audit & Supervisory Board members with an emphasis on diversity, including gender and internationality, and from the viewpoint of striking a balance between experience, skills, and expertise so as to promote accurate and swift decision-making.
Procedures	<ol style="list-style-type: none"> <li>1 <ul style="list-style-type: none"> <li>• The president and the director in charge of human resources listen to opinions based on various perspectives and select suitable candidates to serve as a member of the Board of Directors, comprehensively taking into account their background, personality, insight, and other factors. The president and relevant directors then submit their selections to the Officer Nomination and Compensation Advisory Council to list the candidates for selection for the current fiscal year.</li> <li>• The Officer Nomination and Compensation Advisory Council is chaired by an independent outside director and comprises the president, the director in charge of human resources, and outside directors.</li> </ul> </li> <li>2 <ul style="list-style-type: none"> <li>• Directors are selected based on an informal resolution by the Board of Directors and deliberation at the General Meeting of Shareholders.</li> <li>• Audit &amp; Supervisory Board members are selected based on an informal resolution by the Board of Directors and deliberation at the General Meeting of Shareholders, with the consent of the Audit &amp; Supervisory Board.</li> </ul> </li> </ol>

## Approach to Director Balance, Diversity, and Size

The Board of Directors consists of members who are familiar with the management of each business and its pressing issues. The composition of the Board strikes a strong balance between expertise, experience, skills, and global perspectives, including those of the outside directors. For the Audit & Supervisory Board, the Company selects persons who possess knowledge related to not only business management but also finance, accounting, and law. In this way, the Company aims to achieve a balance between diverse opinions and secure the necessary level of expertise to ensure that the Board of Directors functions properly.

## Analysis and Evaluation of the Effectiveness of the Board of Directors as a Whole

In fiscal 2021, DENSO had all Board members take a survey involving a four-level evaluation of the operation of the Board of Directors, the agenda items discussed, the process for making resolutions, and support for outside officers during fiscal 2020. The Company also held interviews with the inside officers with the aim of obtaining the frank opinions of Board members regarding issues and areas of improvement. The results of these surveys and interviews were discussed by the outside officers at meetings of the Independent Officer Meeting.

The issues and areas for improvement identified through these surveys and interviews have been reported to the Board of Directors and shared between all members who attend Board meetings. By doing so, these surveys and interviews will help enhance the effectiveness of the Board of Directors. The issues and areas of improvement for fiscal 2020 identified through these surveys and interviews are as follows.

### Results of Analysis

The survey evaluated four levels related to the effectiveness of the Board of Directors: (1) Composition of the Board of Directors, (2) operation of the Board of Directors, (3) roles and responsibilities of the Board of Directors, and (4) support for outside officers.

#### 1. Composition of the Board of Directors

Evaluation results: Relatively high evaluation overall, with the highest praise for the majority of members being outside members  
Issues:

- Insufficient balance regarding the gender and internationality of inside officers
- Must increase the number of outside directors with corporate experience

#### 2. Operation of the Board of Directors

Evaluation results: High evaluation for the number of agenda items, time allocation, explanatory materials, and decision-making  
Issues:

- Large number of materials with a significant amount of technical terms
- Too often statements are made by members only after they are called upon by the chair

#### 3. Roles and Responsibilities of the Board of Directors

Evaluation results: Evaluation of "oversight of management" and "environment that supports risk taking" improved from "2. Fairly good" to "1. Good," with some issues still remaining  
Issues:

- Need for examinations and discussions regarding scenarios to win over the competition
- Clarification of the relationship between these scenarios and the Company's medium-term plans
- Need for more opportunities for interaction between outside and inside members as well as the enhancement of information provision

#### 4. Support for Outside Officers

Evaluation results: High evaluation of preliminary explanations and a high level of expectations toward on-site visits. However, many issues were identified, with a high percentage of items being evaluated as "2. Fairly good" or "3. Somewhat insufficient."  
Issues:

- Insufficient number of meetings of the Independent Officer Meeting
- As on-site visits are an important opportunity to learn about the Company, need to increase the number of visits to facilities and secure time for asking questions during visits

<b>Measures for Improvement</b>	
<ul style="list-style-type: none"> <li>• Roles and Responsibilities</li> </ul> <ol style="list-style-type: none"> <li>1. Include the conditions of competitors and DENSO's related strategies within explanatory materials</li> <li>2. Explain long-term policies, long-term vision, and medium-term plans and clarify their relationship with each individual agenda item</li> <li>3. Share details of discussions and issues pointed out by the Management Deliberation Meeting regarding agenda items at Board of Directors' meetings in preliminary explanations</li> </ol>	<ul style="list-style-type: none"> <li>• Support for Outside Officers</li> </ul> <ol style="list-style-type: none"> <li>4. Increase the number of meetings of the Independent Officer Meeting and list topics of discussion in advance so that close deliberations can be held between the independent officers</li> <li>5. Continue to hold on-site visits of the manufacturing front lines in Japan and work to increase the time for Q&amp;A sessions and dialogue during these visits</li> </ol>

## Outside Directors and Outside Audit & Supervisory Board Members

Outside Directors	Reason for Appointment	Attendance at Meetings of the Board of Directors (Fiscal 2020)
George Olcott*	George Olcott has managerial experience at foreign capital companies, including his experience as the head of the Tokyo Branch of a U.K.-based investment advisory company. He currently serves as a Guest Professor at Keio University, Faculty of Business and Commerce, specializing in human resource development and corporate governance in global management. Since assuming the position of Outside Director of the Company in June 2014, he has contributed to the improvement of the Company's corporate value from the perspective of global management. The Company appointed him as an Outside Director in the expectation that he will continue to provide insight that will be reflected in the Company's management.	14/14
Shigeki Kushida*	Shigeki Kushida has the experience of having led diverse activities toward the development and stability of the Japanese economy at Japan's central bank, which serves as the center of the Japanese economy, by filling the posts of Director-General and Executive Director of the Bank of Japan. He currently serves as Director, Representative Executive Officer & President at Japan Securities Finance Co., Ltd. The Company has appointed him as an Outside Director in the expectation that he will continue to apply his broad expertise in the global monetary economy in the Company's management.	11/11
Yuko Mitsuya*	Yuko Mitsuya has an abundance of experience and knowledge in many fields, having long been in management at several corporations and associations and filling the posts of officer and committee member at several sports associations. She currently serves in such positions as Outside Director, The Fukui Bank, Ltd.; Outside Director (Audit and Supervisory Committee Member), JXTG Holdings Inc.; and President, Japan Basketball Association. The Company has appointed her as an Outside Director in the expectation that she will continue to apply her abundance of corporate management-related expertise in the Company's management.	9/11

Outside Audit & Supervisory Board Members	Reason for Appointment	Attendance at Meetings of the Board of Directors and Audit & Supervisory Board (Fiscal 2020)
Yasuko Goto*	Yasuko Goto serves as a director and audit and supervisory committee member at Kyushu Railway Company. She has a broad range of experience as an administrator for the Ministry of Land, Infrastructure, Transport and Tourism as well as the vice governor of Yamagata Prefecture, the head of the JNTO New York Office, and the managing director of Kyushu Railway Company. She also has abundant insight on finance, accounting, and legal compliance as she currently serves in such roles as director and audit and supervisory committee member at Kyushu Railway Company and external audit and supervisory committee member at Shiseido Company, Limited. The Company has appointed her as an outside Audit & Supervisory Board member in the expectation that she will leverage her extensive experience and insight in the Company's auditing activities.	(Board of Directors) 11/11 (Audit & Supervisory Board) 10/10
Haruo Kitamura*	Haruo Kitamura serves as chief of Kitamura Certified Public Accountant Office. He has vast experience in corporate management at many corporations in addition to his extensive career and considerable knowledge as a certified public accountant. The Company has appointed him as an outside Audit & Supervisory Board member in the expectation that he will leverage his deep insight related to accounting and his years of experience in corporate management in the Company's auditing activities.	(Board of Directors) 11/11 (Audit & Supervisory Board) 10/10

\* Independent officers

### Criteria for Judging the Independence of Outside Directors and Outside Audit & Supervisory Board Members

With respect to the independence of outside directors and outside Audit & Supervisory Board members, assuming that they fulfill the independence criteria stipulated by the Financial Instruments and Exchange Act, they must possess a wealth of experience and knowledge in specialized areas

such as corporate management, law, accounting, and finance and are required to be able to proactively make proposals, suggestions, and give opinions about management issues. The Company declares that five outside officers who meet the qualifications for independent director and Audit & Supervisory Board member are independent officers.

## Executive Compensation

### Compensation System

In June 2020, we introduced a restricted stock compensation plan for eligible directors. This plan serves as a means to promote efforts toward medium- to long-term improvement in corporate value as well as management from the perspective of our shareholders. Furthermore, the plan is designed to have the eligible directors further share value with the shareholders and to provide them with more incentives to enhance corporate value over the medium to long term. With the addition of this plan, our new system for director compensation (excluding non-executive directors and outside directors) consists of basic compensation (fixed amount), a bonus (short-term incentive), and share-based compensation (medium- to long-term incentive). The ratios of basic compensation, bonus, and share-based compensation are set at roughly 60%, 30%, and 10%, respectively. Also, we will continue to monitor the impact of

introducing share-based compensation and will consider increasing the ratio of share-based compensation accordingly.

Under this new compensation plan, the compensation paid to eligible directors for granting shares with restriction on transfer comes in the form of monetary claims, and its total amount will be up to ¥200 million. Also, in conjunction with the introduction of this compensation plan, we transitioned to a yearly limit on compensation for directors rather than a monthly limit. At the same time, we set the yearly limit on compensation at ¥1.0 billion (including compensation for outside directors of up to ¥150 million).

Compensation for non-executive directors, outside directors, and Audit & Supervisory Board members comprises only basic compensation (fixed amount) in order to ensure independence from management.

Also, we do not have a system in place for retirement benefits and stock options.

### Breakdown of Compensation System After Revisions (versus Before Revisions)

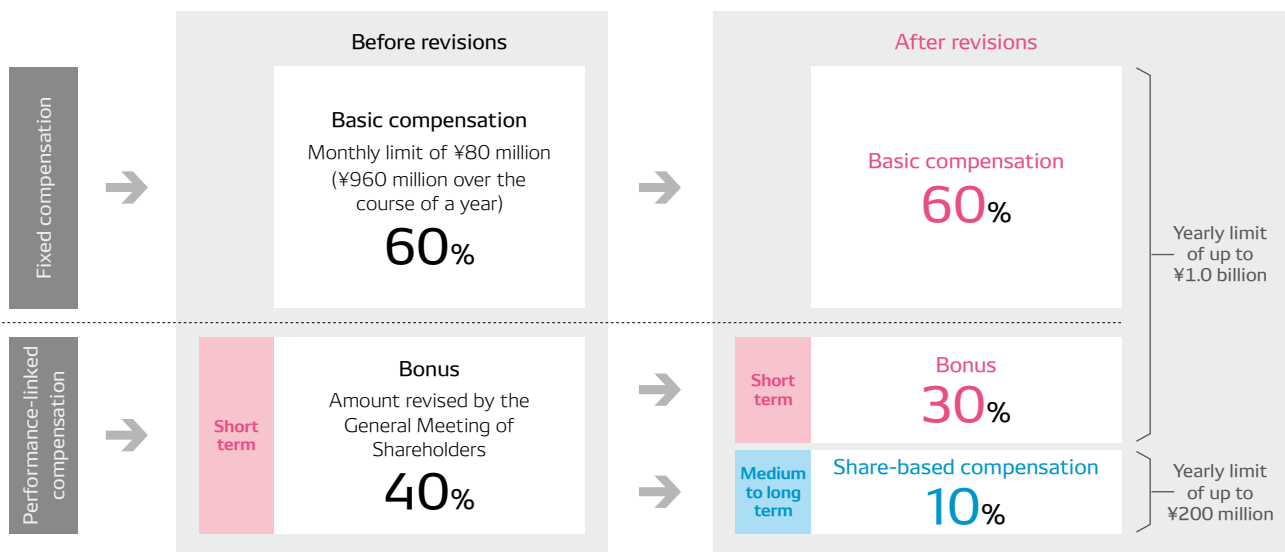

### Compensation of Directors and Audit & Supervisory Board Members

Position	Total Compensation (¥ million)	Total Compensation by Type (¥ million)		Directors / Audit & Supervisory Board Members
		Base	Bonuses	
Directors (excluding outside directors)	316	255	61	6
Audit & Supervisory Board members (excluding outside Audit & Supervisory Board members)	94	94	—	2
Outside directors	73	73	—	9

Note: The above amounts include those for Haruya Maruyama and Takashi Nawa, who retired from the post of director; Moritaka Yoshida and Toshimichi Kondo, who retired from the post of Audit & Supervisory Board member; and Noriyuki Matsushima, who resigned from the post of Audit & Supervisory Board member at the conclusion of the 96th Ordinary General Meeting of Shareholders held on June 26, 2019.

## Strategic Shareholdings

### Basic Stance

To maintain and improve corporate value over the long term in a fast-changing global market, it is essential that we collaborate with outside parties, including promoting joint technological development with various other companies and maintaining and strengthening relationships with business partners. To that end, we hold the number of strategic shareholdings necessary for our business strategies.

### Details of Examination to Determine the Appropriateness of Strategic Shareholdings

Every year, the Board of Directors comprehensively determines the appropriateness of cross-shareholdings by examining the management significance of holding each individual stock, including in terms of promoting joint development and strengthening business collaboration, as well as whether the return on holding said stock (dividend payments, increased share prices, relevant business profit, etc.) is greater than the Company's weighted average cost of capital.

The Company takes steps to reduce the number of cross-shareholdings in the event that the continued holding of such shares is no longer deemed rational through the above process.

### Standard for Exercising Voting Rights

DENSO believes that its investee companies should engage in management that emphasizes improving shareholder interest over the medium to long term, rather than pursuing shareholder returns only in the short term. Giving first and foremost priority to our investee companies that contribute to our profits, we exercise voting rights in an effort to help our investee companies realize sustainable growth and improve their corporate value over the medium to long term.

We comprehensively consider the merits of each item under examination regarding the exercising of votes based on our established internal guidelines. When necessary, we hold dialogues with our investee companies regarding the content of our proposals.

### Shares Held for Purposes Other Than Pure Investments

	Number of stocks		Stocks for which the number of shares increased during the fiscal year under review	Stocks for which the number of shares decreased during the fiscal year under review
	Balance sheet amounts			
Unlisted shares	87 stocks ¥37,711 million (year-on-year decrease: ¥12,964 million)		7 stocks ¥4,901 million	4 stocks ¥1,797 million
Shares other than unlisted shares	35 stocks ¥386,327 million (year-on-year decrease: ¥75,280 million)		1 stock ¥36,683 million	12 stocks ¥14,798 million

Note: The increase in stocks for which the number of shares rose is due to the acquisition of shares necessary for business strategies toward realizing the Group's sustainable growth.

## Establishing and Strengthening Internal Controls

With the aim of fair and efficient business operations, the Company formulated the DENSO Basic Policies for Internal Control. We have stipulated basic policies for control, various rules, and systems in areas that form the basis of our management such as the code of conduct, management systems, risk management, and compliance. We make revisions and changes when necessary after undertaking regularly scheduled annual verifications of the status of implementation.

 DENSO Basic Policies for Internal Control:  
<https://www.denso.com/global/en/-/media/global/about-us/sustainability/governance/management/management-doc-internal-control-policy-2019-en.pdf>



For example, at DENSO CORPORATION, we have established a Business Ethics Hotline that allows anonymous reporting; is independent from the normal chain of command; and is administered by outside attorneys and the Risk Management Promotion Department in accordance with Japan's Whistleblower Protection Act. This hotline can be used by all persons working at DENSO CORPORATION, including employees, temporary employees, and employees contracted from other companies, in addition to principal suppliers (300 companies). In fiscal 2020, the hotline received 130 consultations and reports regarding matters such as employment, labor, work environment, information management, business transactions, and accounting, all of which were addressed appropriately after staff investigated the situation and confirmed the facts.

Number of consultations and reports received	Fiscal 2018	Fiscal 2019	Fiscal 2020
		71	89

### Internal Reporting System

In accordance with the circumstances in each region of operation, the DENSO Group has set up internal reporting systems at its regional headquarters and each business site. These systems allow employees to report their concerns and receive consultation on matters related to legal and regulatory violations via email, telephone, written correspondence, or face-to-face interaction.

## Dialogue with the Outside Directors

Aiming to achieve the kind of governance and management supervisory functions that are needed during this time of monumental change



Shigeki Kushida  
Outside Director

George Olcott  
Outside Director

Yuko Mitsuya  
Outside Director

The automotive industry is currently experiencing the dual impact of a technological paradigm shift, which is said to occur once every 100 years, and the spread of COVID-19. DENSO's three outside directors held a candid conversation on the kinds of reforms the Company needs to pursue to maintain its position as a leading global Tier 1 supplier, with a particular focus on governance.



## Please tell us your overall impressions on the current state of DENSO's governance.

**Kushida:** This is my first time serving as an outside director, and it took me some time to find my bearings. Even in this short period of time, I feel that I have been able to observe on so many occasions DENSO's unique stance as a global manufacturer. At meetings of the Board of Directors, the Company takes great care to provide the outside directors with opportunities to speak. Additionally, while it is an advisory body, the Officer Nomination and Compensation Advisory Council has been established, and I have the honor of serving as its chair. In light of this, I have received the impression that DENSO is a company that is making a sincere effort to strengthen governance as part of its growth strategy.

**Mitsuya:** No matter where you serve, the first year as an outside director is always difficult. Without prior experience, you have no knowledge of the past events that shape the current position of the company. In the case of a manufacturing company such as DENSO, a certain level of technical knowledge is also required. DENSO has been very thorough in providing support to the outside directors in this regard, with the secretariat offering detailed briefings prior to each Board meeting. Thanks to this kind of arrangement, I am able to engage in substantive discussions at Board meetings. Furthermore, DENSO conducts extensive reviews of past investments, which allows me to evaluate previous investment decision-making prior to my appointment as outside director. In these ways, DENSO practices a unique form of governance from various perspectives, including the council process, rather than simply adhering to the governance requirements stipulated by law.

**Olcott:** In the six years that I have served as an outside director at DENSO, there have been major developments related to the governance of Japanese companies, such as the introduction and revision of Japan's Corporate Governance Code and Stewardship Code. In response to these events, DENSO has made steady progress with its governance during my time as an outside director. For example, the size of the Board has been reduced from 14 to eight members, and the number of outside directors has increased from two to three. While DENSO has always provided an environment in which it is easy for the outside directors to comment on various aspects of the Company, these initiatives have made it easier to reflect

the objective perspectives of outside directors in Board discussions than ever before.

A particularly important milestone in terms of DENSO's governance has been the enhancement of the Officer Nomination and Compensation Advisory Council. Launched in fiscal 2017, this organization now engages in vigorous discussions on succession planning and other important matters. The outside directors who are members of the Officer Nomination and Compensation Advisory Council are evaluating specific candidates for the most senior executive positions, meeting with them and engaging in concrete discussions at the council on succession, including the kind of career path that candidates should pursue to equip them for the top positions and the kind of support the Company should provide these candidates. In this manner, the overall nomination process at DENSO has undergone a significant change.

Moreover, in addition to the appointment of Mr. Kushida and Ms. Mitsuya, as of this year the Board has made further changes to its composition with the appointment of Board member Akio Toyoda. The Company has also taken greater steps to enable us to participate deeply in discussions at Board meetings, including detailed pre-Board briefings. I believe this is another major step forward for DENSO's governance.

**Mitsuya:** Whether it be the outside directors or Mr. Toyoda, we all have distinctive personalities, and this enables the Board to gain an overall awareness of a broad range of perspectives. One statement that Mr. Toyoda made which particularly resonated with me was when he talked about the distinctive perspectives of automotive OEMs and those of the automotive component suppliers, emphasizing that while they seem similar in nature, there are frequent occasions when the perspectives are not necessarily aligned. I found this idea quite fascinating. I truly feel that it is these kinds of diverse opinions that have further energized discussions at Board meetings.

## What issues need to be addressed in order to further strengthen the function of the Board of Directors?

**Kushida:** The Board plays two roles: determining the direction of the company and monitoring business execution. For monitoring in general, there needs to be standards with which we can measure the progress of initiatives.

## Profile

### ● George Olcott

Mr. Olcott has been serving as an outside director at the Company since 2014. He also teaches as a guest professor at Keio University, Faculty of Business and Commerce.

### ● Shigeki Kushida

Mr. Kushida has been serving as an outside director at the Company since 2019. He also serves as president and representative executive officer at Japan Securities Finance Co., Ltd., and has experience working at the Bank of Japan.

### ● Yuko Mitsuya

Ms. Mitsuya has been serving as an outside director at the Company since 2019. She also serves as representative director of SORA Corporation and has a long history in the sports world.

## Dialogue with the Outside Directors

In the case of DENSO, the Company has in place several plans that go alongside its quantitative financial targets, including the Long-term Plan targeting 2025, the Mid-term Policy for 2021, and other plans that are formulated for each fiscal year. Taking steps to form organic connections between these medium- to long-term perspectives and short-term perspectives is an issue we must tackle going forward.

Also, to improve our monitoring activities, it is imperative that we constantly update our awareness of the changing external environment, which forms the basis for these activities, and modify our approach accordingly. At the same time, as software becomes increasingly central to our business, a significant theme we must consider is how to integrate our actions over an approximate five-year span in the automotive industry, which is the conventional timeframe for changes to occur, with our actions over the same period of time in the software development domain, which undergoes constant and rapid change.

Going forward, I hope that we can deepen our discussions on these various issues and work to further enhance the monitoring functions of the Board of Directors.

**Olcott:** First of all, I believe we need to hold genuine discussions to clarify our financial benchmarks for enhancing our earning power. In these discussions, it is particularly important to consider the perspectives of capital allocation, capital costs, and the profitability of each individual product.

Furthermore, management would benefit from medium- to long-term scenario planning related to the Company's business activities and to societal trends as a whole. For example, the development timeframe for advanced driver assistance systems (ADAS) is something for which we can naturally make estimations. At the Board, we therefore need to engage more thoroughly in discussions that focus on weighing the validity of such estimations and identifying issues that could occur within that timeframe making use of a backcasting approach. We also need to discuss elements of uncertainty that could impact the scenarios we have envisioned. Deepening discussions of this nature is an issue that I believe all Japanese companies need to improve upon.

**Mitsuya:** The automotive industry is currently experiencing the dual impact of a technological paradigm shift and the spread of COVID-19, both of which are said to be once-in-a-100-year events. In such times of crisis, management needs a clear idea of the circumstances in which it is operating, and that is what we as outside directors must observe closely. In this way, I believe that the concept of self-monitoring by the Board will change going forward.

In addition to having the courage to push forward with initiatives, we also need to have the courage to stop when necessary. This means that we should avoid concerning ourselves too much with accomplishing the plans we have formulated no matter what the circumstances.

Rather, we should adopt a flexible approach that includes downward revisions to targets in accordance with the changing situation. In this period of significant volatility, I believe we will have to re-envision the best approach to governance and monitoring activities.

**Kushida:** CASE is a revolutionary technology that is making our world more convenient. However, this does not necessarily mean that CASE will immediately provide a positive boost to the automotive industry. Actually, Mr. Toyoda put it best when he stated that CASE presents a life-or-death scenario for companies. The trend of reorganization is actually being accelerated in the automotive industry to generate resources for large-scale investments to develop technologies such as CASE. While large investments of this nature are necessary, they will not produce immediate returns. Accordingly, what supports a company until returns are realized is the profitability of existing, mature business fields. DENSO's strength as a global Tier 1 supplier is its ability to balance enhanced vehicle safety with low costs, underpinned by its long-cultivated technologies. This strength is precisely what allows DENSO to take on challenges in cutting-edge domains.

From this perspective, it is of the utmost importance that DENSO's management takes the gravity of the recent quality-related issue to heart and enacts an appropriate response on a Groupwide basis. By coming together as a company to rectify this issue, I hope that DENSO is able to reaffirm the source of its strengths.

**Olcott:** DENSO is a company that takes great pride in its *Monozukuri* capabilities. However, the Company needs to be careful not to develop the misconception that its pedigree will prevent quality-related issues from occurring. Furthermore, when we have a quality-related issue such as the recent one occur, the outside directors have the responsibility to thoroughly monitor DENSO's response across the organization. My personal judgment is that DENSO is reflecting on the situation with the utmost sincerity and taking earnest steps to prevent future recurrence.

### How do you evaluate DENSO's response to the issue of COVID-19?

**Mitsuya:** DENSO's response has been very swift. COVID-19-related issues were already being reported at meetings of the Board of Directors in February. In addition, President Arima laid out a bold policy to minimize the possibility of any employee contracting the virus, and based on this policy, DENSO promptly provided instructions on a global basis and worked to thoroughly enforce them. Also, all important information was centralized with the president and the chief risk officer (CRO), enabling a crisis management response focused on the entire supply chain. I felt that the speed of each division's information gathering



and response efforts was extremely impressive and befitting of a global manufacturing company.

**Olcott:** I also feel that DENSO has handled the situation extremely well. Information was promptly centralized with the CRO and disseminated accordingly, and I also give high praise to such efforts as the in-house production of masks.

However, what is important now is DENSO's medium- to long-term response in the "Post-COVID-19" era. Compared with Europe and the United States, Japan is generally behind in terms of establishing an environment for teleworking. If overseas competitors can leverage teleworking to significantly reduce fixed costs and make other operational improvements, this could create a genuine life-or-death issue for Japanese companies, which tend to have structural difficulties reducing headcount. To maintain its competitiveness, it is of paramount importance that DENSO strives to enhance productivity through dramatic workstyle reforms.

**Kushida:** The promotion of teleworking not only ensures business continuity but also helps realize diverse workstyles. When looking at today's standards, I feel that society as a whole has taken a major step forward in terms of workstyle reforms. DENSO is a manufacturing company, and while for that reason there may be difficult aspects regarding teleworking, I very much hope that the Company is able to draw on the experience it has gained from the COVID-19 crisis to initiate improvements going forward.

### What are your aspirations for enhancing corporate value in the near term?

**Olcott:** As I stated previously, I aim to help DENSO deepen its discussions on enhancing profitability. Establishing a shared awareness of this issue will enable DENSO to not only execute strategic investment in fields to enhance corporate value but also make bold exits from unprofitable businesses.

Also, low-cost production is currently expanding in emerging countries while at the same time IT and other companies from different industries are making an entry

into the automotive industry. In response to these circumstances, there will likely be a need for DENSO to explore collaboration with other companies in a flexible manner. To that end, DENSO must be able to promote itself as an attractive business partner to other companies. From the perspective of an outside director, I will provide appropriate advice to help DENSO tackle these new challenges.

**Mitsuya:** DENSO adheres to the principle of "*Monozukuri* is *Hitozukuri* (manufacturing excellence is people excellence)." I have been involved in coaching sports for a long period, and I therefore hope to draw on my various expertise to support DENSO in terms of team building and human resource development. While AI and robotics will become more widespread in the future, there will conversely be an emergence of areas that can only be handled by people. What will be important to consider in the times to come is how we will select and subsequently develop our personnel. While maintaining an awareness of objective outside perspectives, I will contribute to DENSO's *Hitozukuri* (people excellence) that will underpin new kinds of *Monozukuri* (manufacturing excellence).

**Kushida:** Due to the introduction of cutting-edge technologies from other industries and the rapidly changing needs of consumers, we find ourselves in a time when we must drastically rethink the common practices and paradigms that have dominated the automotive industry to date. To do so, external experts such as ourselves will be expected to shed light on areas that are difficult to see by experts who have worked primarily in the automotive industry. We will also be expected to serve as a "medium" for vigorous discussions.

Every individual is different. Matters that one person considers and feels to be obvious can come as a completely new surprise to another person. The existence of these differences between people can become an effective tool when considering the response to various issues. By offering diverse and objective perspectives from outside the Company's organization and industry, I will strive to help DENSO grow into an even more outstanding company.

# Directors and Audit & Supervisory Board Members

(As of June 19, 2020)

## Directors



President & CEO

### Koji Arima

(Date of birth: February 23, 1958)  
1981 Joined DENSO CORPORATION  
2008 Executive Director,  
DENSO CORPORATION  
2014 Senior Executive Director,  
DENSO CORPORATION  
2015 President & CEO, DENSO  
CORPORATION (current position)



Executive Vice President

### Yasushi Yamanaka

(Date of birth: March 10, 1957)  
1979 Joined DENSO CORPORATION  
2005 Executive Director, DENSO CORPORATION  
2014 Senior Executive Director,  
DENSO CORPORATION  
2015 Executive Vice President,  
DENSO CORPORATION (current position)



Executive Vice President

### Hiroyuki Wakabayashi

(Date of birth: January 15, 1956)  
1979 Joined DENSO CORPORATION  
2006 Executive Director, DENSO CORPORATION  
2013 Senior Executive Director, Member of the  
Board, DENSO CORPORATION  
2014 Director, Member of the Board, Senior  
Executive Director, DENSO CORPORATION  
2015 Senior Executive Director,  
DENSO CORPORATION  
2016 Director, Member of the Board, Senior  
Executive Director, DENSO CORPORATION  
2017 Executive Vice President,  
DENSO CORPORATION (current position)



Executive Vice President

### Sadahiro Usui

(Date of birth: September 9, 1958)  
1981 Joined DENSO CORPORATION  
2007 Executive Officer, DENSO CORPORATION  
2015 Senior Executive Officer,  
DENSO CORPORATION  
2019 Vice President, DENSO CORPORATION  
2020 Executive Vice President,  
DENSO CORPORATION (current position)



Member of the Board

### Akio Toyoda

(Date of birth: May 3, 1956)  
1984 Joined Toyota Motor Corporation  
2000 Member of the Board of Directors,  
Toyota Motor Corporation  
2002 Managing Director, Toyota Motor Corporation  
2003 Senior Managing Director, Toyota Motor Corporation  
2005 Executive Vice President, Toyota Motor Corporation  
2005 Outside Member of the Audit & Supervisory Board,  
Koyo Seiko Co., Ltd. (currently JTEKT CORPORATION)

2006 Outside Audit & Supervisory Board Member,  
TOYOTA BOSHOKU CORPORATION  
2009 President, Toyota Motor Corporation (current position)  
2018 Chairman, Japan Automobile Manufacturers Association,  
Inc. (current position)  
2019 Director, Member of the Board,  
DENSO CORPORATION (current position)



Outside Director **Independent Officer**

### George Olcott

(Date of birth: May 7, 1955)  
1986 Joined S.G. Warburg & Co., Ltd.  
1991 Director, S.G. Warburg & Co., Ltd.  
1993 Executive Director, Equity Capital Market Group,  
S.G. Warburg Securities London  
1997 Head of Tokyo Branch, SBC Warburg  
1998 Vice President, LTCB-UBS-Brinson Asset Management  
1999 President, UBS Asset Management (Japan) President,  
Japan UBS Brinson  
2000 Managing Director, Equity Capital Market,  
UBS Warburg Tokyo  
2001 Judge Business School, University of Cambridge  
2005 FME Teaching Fellow, Judge Business School,  
University of Cambridge  
2008 Senior Fellow, Judge Business School,  
University of Cambridge  
2008 Outside Director, Nippon Sheet Glass Co., Ltd.

2010 Outside Director, NKSJ Holdings, Inc.  
2010 Project Professor, Research Center for Advanced Science  
and Technology, The University of Tokyo  
2014 Guest Professor, Keio University Faculty of Business and  
Commerce (current position)  
2014 Outside Director, Hitachi Chemical Company, Ltd.  
(current position)  
2014 Director, Member of the Board,  
DENSO CORPORATION (current position)  
2015 Outside Director, The Dai-ichi Life Insurance Company,  
Limited  
2016 Outside Director, BlueOptima Limited (current position)  
2016 Outside Director, Dai-ichi Life Holdings, Inc.  
(current position)  
2016 Outside Director, JP Morgan Japanese Investment Trust plc  
(current position)  
2020 Outside Director, Kirin Holdings Company, Limited  
(current position)



Outside Director **Independent Officer**

### Shigeki Kushida

(Date of birth: June 8, 1958)  
1981 Joined Bank of Japan  
2004 Branch Manager, Kochi Branch, Bank of Japan  
2009 Director-General, Personnel and Corporate Affairs  
Department, Bank of Japan  
2010 Director-General, Planning Department, Bank of Japan  
2011 Branch Manager, Nagoya Branch, Bank of Japan

2013 Executive Director, Bank of Japan  
Entrusted Branch Manager, Nagoya Branch and  
Osaka Branch, Bank of Japan  
2017 Senior Advisor, American Family Life Insurance Company  
(currently Aflac Life Insurance Japan Ltd.)  
2019 Director, Representative Executive Officer & President,  
Japan Securities Finance Co., Ltd. (current position)  
2019 Director, Member of the Board,  
DENSO CORPORATION (current position)



Outside Director **Independent Officer**

### Yuko Mitsuya

(Date of birth: July 29, 1958)  
1981 Joined Hitachi, Ltd.  
2007 Representative Director, PSY-fa Co., Ltd.  
2014 Outside Audit & Supervisory Board Member,  
ASICS Corporation  
2015 Outside Director, Fujita Kanko Inc.  
2015 Outside Director, Paloma Co., Ltd.  
2016 President, Japan Basketball Association (current position)

2018 Representative Director, SORA Corporation  
(current position)  
2018 Outside Director, The Fukui Bank, Ltd. (current position)  
2019 Outside Director, JXTG Holdings, Inc. (current position)  
2019 Director, Member of the Board,  
DENSO CORPORATION (current position)

## Audit & Supervisory Board Members



### Standing Audit & Supervisory Board Member Atsuhiko Shimmura

(Date of birth: June 28, 1957)  
1980 Joined DENSO CORPORATION  
2009 Executive Vice President,  
DENSO International America, Inc.  
2014 Director, Corporate Planning Division,  
DENSO CORPORATION  
2014 Standing Audit & Supervisory Board Member,  
DENSO CORPORATION (current position)



### Standing Audit & Supervisory Board Member Motomi Niwa

(Date of birth: November 3, 1962)  
1985 Joined DENSO CORPORATION  
2007 Head of Function Products Planning Division  
(currently Powertrain Components  
Business Unit, Powertrain Components Business  
Planning Department), DENSO CORPORATION  
2013 Director, Human Resources Division,  
DENSO CORPORATION  
2014 Vice President,  
DENSO Manufacturing Athens Tennessee, Inc.  
2018 Standing Audit & Supervisory Board Member,  
DENSO CORPORATION (current position)



### Outside Audit & Supervisory Board Member **Independent Officer** Yasuko Goto

(Date of birth: February 19, 1958)  
1980 Joined the Ministry of Transport  
2004 Head, New York Office,  
Japan National Tourism Organization  
2005 Vice Governor, Yamagata Prefecture  
2008 Director, Regional Transport Bureau of Hokuriku and  
Shinetsu Regions, Ministry of Land, Infrastructure,  
Transport and Tourism (MLIT)  
2013 President, Policy Research Institute for Land,  
Infrastructure, Transport and Tourism, MLIT

2015 Managing Director, Deputy General Manager of Railway  
Operations Headquarters and General Manager of  
Tourism Business Headquarters, Kyushu Railway Company  
2017 Managing Director in charge of Finance Department,  
Kyushu Railway Company  
2018 Director, Audit & Supervisory Committee Member,  
Kyushu Railway Company  
2019 External Audit & Supervisory Committee Member,  
Shiseido Company, Limited (current position)  
2019 Outside Audit & Supervisory Board Member,  
DENSO CORPORATION (current position)



### Outside Audit & Supervisory Board Member **Independent Officer** Haruo Kitamura

(Date of birth: August 21, 1958)  
1983 Joined Arthur Andersen Konin Kaikeshi Kyodo Jimusho  
(currently KPMG AZSA LLC)  
1987 Registered as a Certified Public Accountant  
2002 Chief, Kitamura Certified Public Accountant Office  
(current position)  
2004 Outside Auditor, ROHM Co., Ltd.  
2005 Outside Director, Sumisho Grainger Co., Ltd.  
(currently MonotaRO Co., Ltd.) (current position)  
2006 Supervisory Director, MID REIT, Inc. (currently MCUBS  
MidCity Investment Corporation) (current position)  
2009 Outside Corporate Auditor, Yamaha Corporation

2010 Outside Director, Yamaha Corporation  
2015 Outside Corporate Auditor, ASMO Co., Ltd.  
(currently DENSO CORPORATION)  
2015 Outside Corporate Auditor, LEGAL CORPORATION  
(current position)  
2016 Outside Corporate Auditor, Toyo Aluminium K.K.  
(current position)  
2019 Outside Audit & Supervisory Board Member,  
DENSO CORPORATION (current position)

## Expertise and Abilities That Can Be Leveraged in the Management of the Board of Directors and Audit & Supervisory Board

Koji Arima	Excellent management prowess and leadership
Yasushi Yamanaka	Expertise and experience gained as a member of leading technology departments
Hiroyuki Wakabayashi	Managerial experience in production and business operations as well as knowledge in advanced fields such as automated driving
Sadahiro Usui	Insight gained through his experience in the business planning department and his involvement in the formulation and implementation of global strategies in important overseas regions of operation
Akio Toyoda	Abundant experience and extensive insight as a leader of the automotive industry
George Olcott	Relevant expertise as well as abundant experience and deep insight related to corporate management
Shigeki Kushida	Wealth of experience leading activities that developed and stabilized the Japanese economy and extensive insight on the global monetary economy
Yuko Mitsuya	Abundant experience in corporate management and many other fields, including as an officer and committee member at several sports associations
Atsuhiko Shimmura	Management experience at the North American headquarters, in addition to extensive knowledge and experience from positions within Company business divisions
Motomi Niwa	Managerial experience at overseas subsidiary and extensive expertise gained from positions in functional and operating departments
Yasuko Goto	Broad range of experience in administrative and corporate management as well as in-depth audit knowledge in finance, accounting, and compliance
Haruo Kitamura	High level of insight related to accounting as a certified public accountant and vast experience in corporate management

# Risk Management

## Basic Stance

To minimize the impact of constantly diversifying risks, DENSO is working to expand and strengthen its risk management structure. Specifically, we have divided matters that have the potential to damage our businesses into “risks,” which refer to circumstances where such matters have yet to manifest, and “crises,” which refer to states of emergency

where such matters have manifested. Based on these classifications, we are focusing our efforts on implementing preventive measures, which stop risks before they occur, and swift and accurate initial-response and recovery measures, which minimize damage in the event a crisis occurs.

## Promotion Structure

DENSO has established the Risk Management Meeting, a Groupwide organization that confirms improvements to the Company’s risk management structure and framework and discusses and determines the direction of important risk management activities based on the conditions and trends both inside and outside the Company. Through this organization, we are taking steps to strengthen measures to prevent damage to our businesses during normal times and measures to minimize damage during times of emergency. In addition, we have created the Crisis Communication Manual in order to respond promptly and accurately in the event of a crisis. Depending on the severity and level of

urgency of the situation, we assemble special countermeasure organizations to enact an agile response geared toward minimizing damage.

In January 2020, with the aim of further enhancing our risk management structure, we appointed a chief risk officer (CRO), who is responsible for Groupwide risk management, and established the Risk Management Promotion Department, which serves as a supervisory organization.



Risk Management Structure:  
<https://www.denso.com/global/en/about-us/sustainability/governance/risk/>



## Ascertaining Risks and Clarifying Response

DENSO makes efforts to constantly ascertain the risks it faces and manage these risks from the perspectives of damage mitigation and business continuity.

The Company has selected 42 risk items related to life, credit, property, and business activities based on frequency of occurrence and level of impact. The Company designates responsible departments for each risk item and clarifies various factors pertaining to these items, including level of

impact, reason for occurrence, preventive measures, initial response, and recovery efforts. The Company also strives to enhance its preventive measures, initial response, and recovery efforts.

DENSO revises its risk items appropriately, giving consideration to the issues currently facing society as well as the frequency of risks occurring at DENSO and the level of impact they have on the Company.

## CRO Message

The automotive industry is currently in the middle of a once-in-a-century paradigm shift. Furthermore, amid not only major changes in the business environment but also the frequent occurrence and increased severity of natural disasters stemming from climate change, we are now dealing with the COVID-19 pandemic, which has brought about brand-new risks the likes of which we have never experienced before. Accordingly, we must once again recognize the great importance of risk management.

DENSO has worked to expand and strengthen its risk management focused on the two perspectives of “prevention,” which involves avoiding risks during normal times through specific measures to respond to significant risks, and “damage minimization,” which involves implementing appropriate initial-response and recovery measures during times of emergency. To reinforce our risk management promotion structure in an era in which it is extremely difficult to forecast the future, we have appointed a chief risk officer (CRO), who is responsible for Groupwide risk management, and established the Risk Management Promotion Department, which serves as an independent organization that oversees the DENSO Group on a cross-organizational basis, in January 2020.

Going forward, we will be faced with the challenges of the “With COVID-19” and “Post-COVID-19” eras. In these eras, changes to people’s lifestyles and the structure of society itself will be unavoidable, including a trend toward nationalism, the shift to non-contact practices, and digitization. In the automotive industry, we will likely see changes in the details and nature of CASE-related trends. As CRO, I will promptly identify and respond to risk under our new risk management promotion structure, together with relevant company divisions.

### Sadahiro Usui

Chief Risk Officer  
Executive Vice President



## Main Risks for DENSO

Reason	Risk Items
Internal factors (Accidents and mistakes)	Environmental pollution and abnormalities, disasters (work-related accidents, fires, and explosions), recalls (quality-related issues), production obstacles (difficulties with energy supply, etc.), <b>information security-related incidents</b> → <b>CASE 1</b> , personnel and work-related incidents (human rights issues, labor issues, and issues at overseas offices), mental health issues, traffic accidents, errors in internal management of information, etc.
Internal factors (Legal violations)	Violations of the Antimonopoly Act, tax evasion, inappropriate employee dispatch or use of contract work, violation of product laws and regulations, violation of anti-bribery laws, etc.
External factors (Natural disasters)	<b>Earthquakes, typhoons, concentrated heavy rains, lightning strikes</b> → <b>CASE 2</b>
External factors (Political and social)	Product liability litigation, fluctuating exchange rates, supplier-related issues, incidents or other emergencies (wars, terrorist attacks, abductions, etc.), <b>spread of infectious diseases</b> → <b>CASE 3</b> , etc.



## Response to Major Risks

### CASE 1 Strengthening Information Security Infrastructure Following the Change toward a “Connected Society”

Following the advancement of such technologies as automated driving and IoT, cyber security risks related to vehicles and production facilities have become a serious issue.

To ensure that vehicles can be used safely and with peace of mind, DENSO is developing technologies that protect in-vehicle products, such as advanced driver assistance systems and automated driving, from cyberattacks. The Company is also moving forward with the establishment of unique frameworks for steadily installing these technologies in vehicles. At the same time, DENSO is setting up security measures for its internal networks, production lines, and other facilities and is working to secure its information assets and realize a steady supply of products to its customers.

Furthermore, we expect to accumulate various information assets internally as a result of progress toward a “connected society,” and these assets will be used in a large number of company divisions.

To ensure that the way we use information assets does not infringe upon the rights and interests of the information provider, we are working to forecast risks from a broad range of perspectives, including contract conditions and adherence to laws and regulations, formulate relevant rules, and establish a structure to appropriately manage and operate these assets.

### CASE 2 Strengthening Natural Disaster Risk Response (Formulation of BCPs\*)

In the near future, a massive earthquake is expected to strike Japan. Also, in addition to the progression of global warming, there is concern that climate change will lead to an increase in the frequency of natural disasters. In the event of a natural disaster, it is of the utmost importance that we protect the lives of our employees. At the same time, in the event a disaster were to disrupt our production and supply activities, it is imperative that we work to swiftly restore operations and minimize the damage to our businesses. At DENSO CORPORATION and domestic Group companies, we have commenced the formulation of BCPs from the perspective of business continuity management. We are also taking action in such ways as creating emergency situation manuals and promoting countermeasures for reducing disasters. Going forward, we will strengthen our response to risks from earthquakes and other natural disasters on a Groupwide basis.

\* BCPs: Business continuity plans. In the event that operations are interrupted by an earthquake or other large-scale natural disaster, BCPs are designed to minimize damage to the Company's business by aiming to promptly restore operations.

### CASE 3 Measures to Respond to Infectious Diseases

DENSO has formulated an action plan to respond to the outbreak or spread of infectious diseases. With the aim of realizing swift and accurate decision-making by the Emergency Response Headquarters, this plan clarifies the details of response measures and roles of each relevant division based on the Company's basic response policies and estimations of damage.

In the event of an infectious disease outbreak, we will promote the necessary measures to prevent and counter the spread of the disease, guided by a basic approach that places the lives and safety of our employees as our top priority. At the same time, we will carry out the most comprehensive response possible, taking into account the circumstances surrounding the continuity of our businesses.

## COLUMN Response to the Outbreak and Spread of COVID-19

After receiving the initial report that COVID-19 was spreading in China, we promptly established the COVID-19 Response Headquarters within our head office, which is headed by an executive vice president who serves as our chief risk officer (CRO). Placing top priority on ensuring the safety of our employees and their families, we examined and provided direction for measures to prevent the spread of COVID-19 and minimize its impact. Additionally, we held daily video conferences with each regional headquarters overseas to facilitate a timely response that catered to the public agency requests and situation in each region. In this way, we gathered information from each region and provided the necessary instruction in accordance with local circumstances.

Furthermore, we rigorously enforced essential measures for preventing the spread of the virus, including having employees take their temperature before reporting to work and wash their hands regularly as well as avoiding situations where crowding can occur. At the same time, we implemented measures such as staggered working hours and encouraged employees to work from home by expanding the application of teleworking, which we had already introduced in an effort to reform our conventional workstyles.

We are still unsure as to when the COVID-19 pandemic will be resolved, and there is also the risk of increased virulence of the virus should it further mutate. Going forward, we will continue to collaborate and collect information in a timely manner on a global scale as we implement response measures in accordance with changes in the conditions and trends of the pandemic.

# Compliance

## Basic Stance

We believe that key actions to earn the trust and understanding of society pertain to the DENSO Group's observance of all applicable national and regional laws and all Group employees' fair and faithful conduct that embodies the highest ethical standards.

Based on this recognition, in 2006 we adopted the Code of Conduct for DENSO Group Associates, which clearly indicates the standards of conduct for each and every

employee. In training and at workplace conferences, we utilize the Code for raising employees' awareness of compliance, which includes all domestic Group companies. Overseas Group companies use a regional version of the Code of Conduct for DENSO Group Associates, formulated by their regional headquarters in accordance with national and regional laws and customs.

## Promotion Structure

In 1997, DENSO created a Business Ethics and Compliance Committee chaired by a director to provide oversight in that area (now integrated into the Management Deliberation Meeting). We have also instituted committee structures, such as the Compliance Committee, and compliance promotion officers, such as compliance leaders, in the regional headquarters of each region of our collective global base.

In doing so, we are building global systems that promote compliance, while at the same time promoting the development of organizational structures that take differing regional characteristics into consideration, the introduction and operation of reporting systems, and the pursuit of enlightenment activities.

## Specific Initiatives

### Educational and Awareness Activities

DENSO implements various educational and enlightenment activities for employees on an ongoing basis with the aim of enhancing their overall awareness of compliance matters.

In Japan, we carry out educational and enlightenment activities related to compliance, including position-based training, various e-learning programs, and the "Business Ethics Month" (every October). We also roll out similar activities for employees in each region of operations, centered on our regional headquarters.

### Inspection and Improvement of Activities

DENSO conducts inspections to ascertain whether its compliance activities have sufficiently taken hold and to look for any potential compliance issues. If an issue is discovered, reports are made to top management when necessary, and steps are taken to prevent a recurrence of the issue. For example, DENSO CORPORATION holds a sustainability survey every year in order to gain an understanding on the extent to which compliance-related measures have taken hold and on potential compliance risks.

### Response to Antitrust Laws

In February 2010, the U.S.-based subsidiary DENSO International America was investigated by the U.S. Department of Justice. Since then, we have established the Antitrust Laws Compliance Committee, chaired by the representative director. Under the guidance and supervision of

this committee, we have endeavored to reinstitute strict compliance with the Antitrust Laws across the entire DENSO Group. These efforts have included ensuring strict adherence to laws and regulations, strengthening education about relevant rules, and conducting more precise audits regarding legal compliance.

### Response to Anti-Bribery Laws

DENSO formulated the "Global Anti-Bribery Policy" to serve as its basic approach to preventing bribery. At the same time, the Company established the Compliance and Anti-Bribery Committee, which is chaired by a relevant Company director. This committee takes the lead and provides supervision on the formulation of bribery prevention rules and the promotion of employee awareness and education measures through e-learning. We also have Sustainability Guidelines for Suppliers in place to prevent bribery between suppliers and third parties. In these ways, we are working to thoroughly prevent bribery throughout the supply chain.

### Response to Tax Compliance

DENSO has established the "Global Tax Policy" to meet its social responsibility through proper tax payment. Under this policy, we actively engage in activities for tax compliance on a Groupwide basis, such as providing training for employees and abiding by rules for cross-border transactions.



Please see the "Sustainability Information" section of DENSO's corporate website for more information.  
Compliance:  
<https://www.denso.com/global/en/about-us/sustainability/governance/compliance/>



Please refer to our corporate website for information on the DENSO Group Global Tax Policy.  
<https://www.denso.com/global/en/-/media/global/about-us/sustainability/governance/compliance/compliance-doc-tax-policy-en.pdf>





DENSO

# 5 Corporate Data

96 Facts & Figures

98 10-Year Data

100 Company Overview and Stock Information



# Facts & Figures

## Financial Highlights

Revenue / Operating Profit / Operating Margin

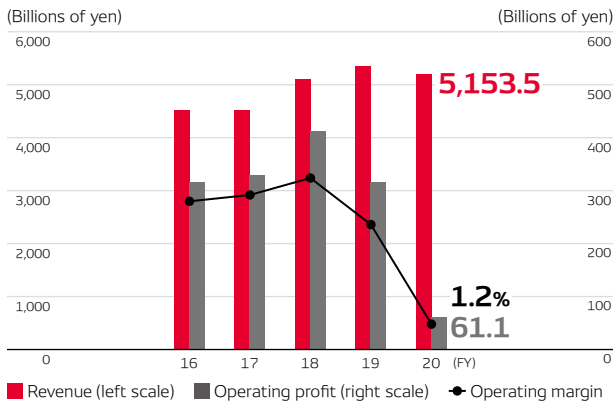

Profit Attributable to Owners of the Parent Company

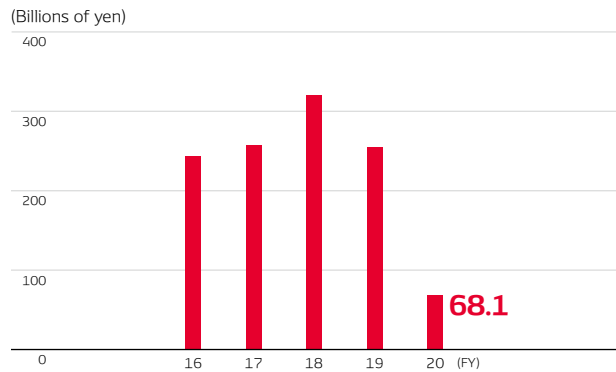

Total Assets / Equity Attributable to Owners of the Parent Company

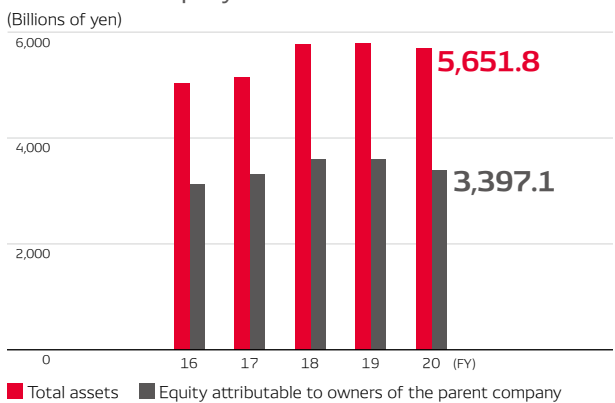

Interest-Bearing Debt\*1 / EBITDA\*2 / Interest-Bearing Debt to EBITDA Ratio

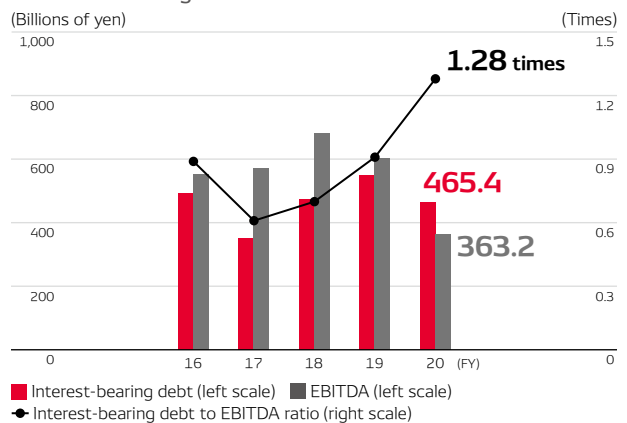

\*1 Interest-bearing debt = Short-term loans and short-term bonds (including long-term loans to be repaid within one year) + Long-term loans and long-term bonds  
\*2 EBITDA = Operating profit + Depreciation

EPS / Cash Dividends per Share / Dividend Payout Ratio

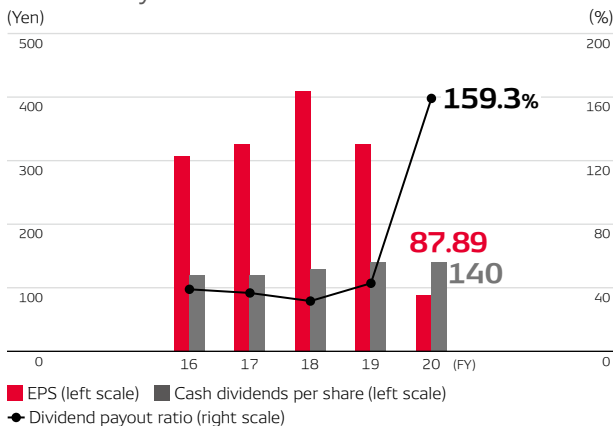

Amount of Treasury Stock Acquired / Total Dividend Amount / Total Return Ratio

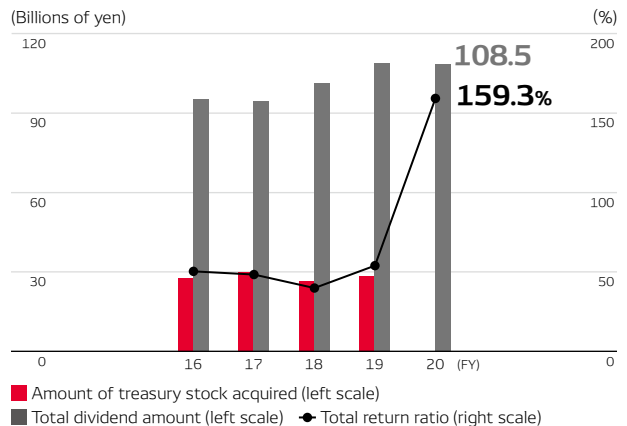

Please see the link below for more financial information.  
<https://www.denso.com/global/en/-/media/global/about-us/investors/annual-report/2020/2020-financial-section.pdf>



## Non-Financial Highlights

### CO<sub>2</sub> Emissions per Unit\* (Non-Consolidated)

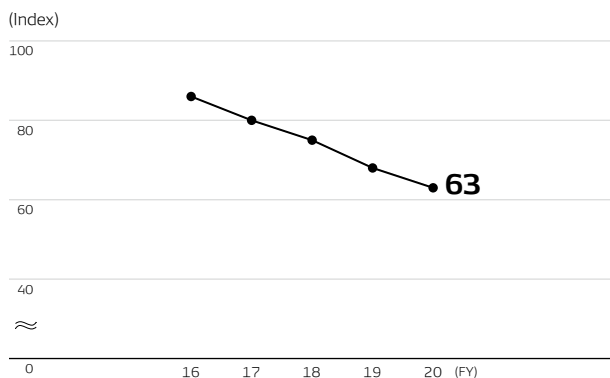

### In-House Power Generation Ratio (Non-Consolidated)

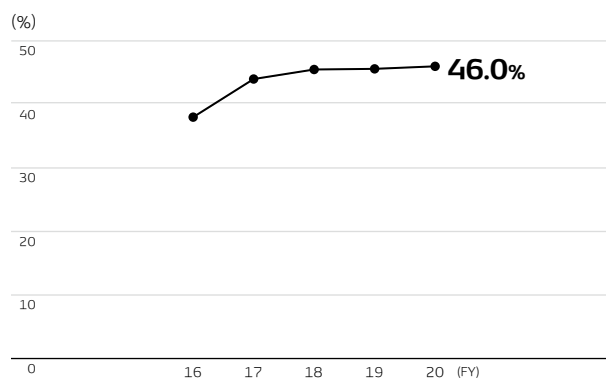

### Ratio of Local Employees in Leadership Roles at Overseas Bases

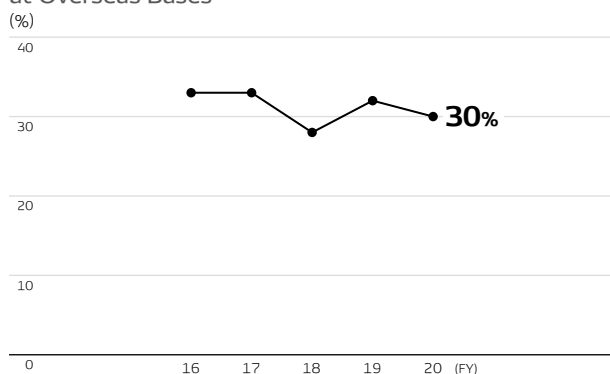

### Number and Ratio of Female Employees in Managerial Positions (Non-Consolidated)

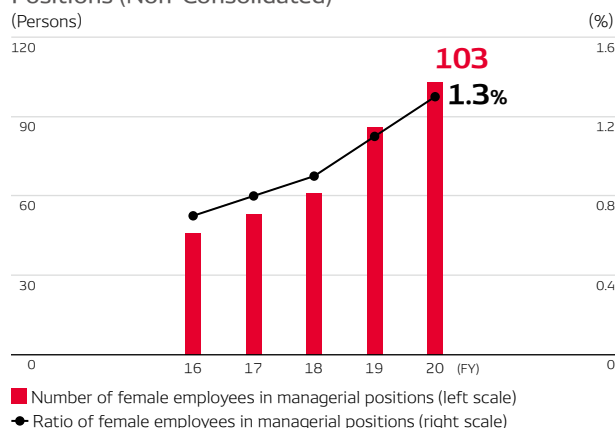

### Number of Patents Held and Patent Applications Filed in Japan and Overseas

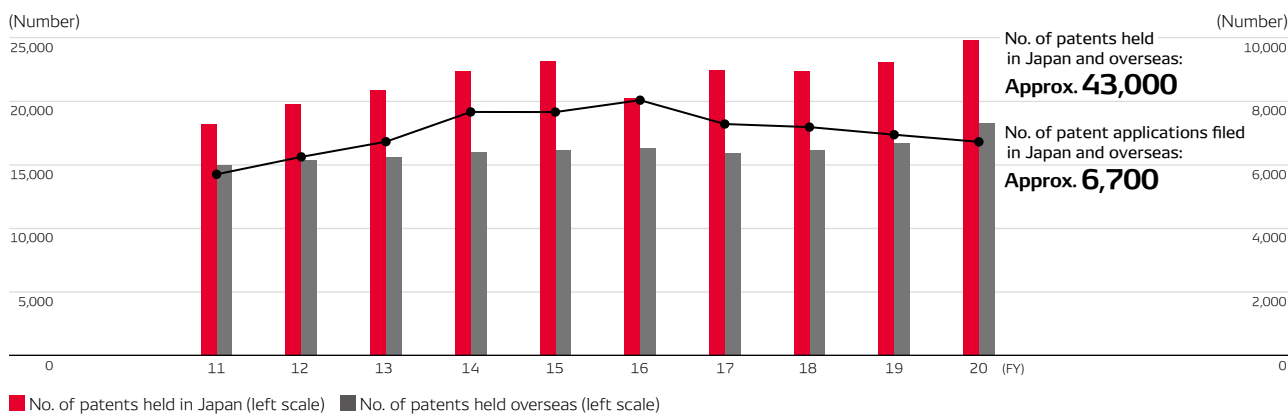

Note: The number of patent applications filed shows the total number of filings in Japan and overseas. This figure includes patents filed during DENSO's fiscal year. The number of patent applications filed in Japan includes withdrawn items for priority claim based on Japanese patent applications and divisional applications. The number of patent applications filed overseas includes continuing and divisional applications.

## 10-Year Data

		Japanese GAAP				
		(FY)	2011	2012	2013	
Financial Data	Revenue	Total	3,131.5	3,154.6	3,580.9	
	By Region*1	Japan	1,548.2	1,640.0	1,808.9	
		North America	528.9	504.1	625.0	
		Europe	389.6	373.2	348.8	
		Asia	604.7	579.8	734.5	
		Others	60.2	57.6	63.8	
		By Customer	OEM	2,813.9	2,813.5	3,220.0
			Toyota Group	1,548.5	1,549.4	1,832.0
			Ratio of revenue from Toyota Group transactions to total revenue	49.4%	49.1%	51.2%
			After market and non-automotive	317.6	341.1	360.9
		Operating Profit		188.3	160.7	262.4
		Operating Margin		6.0%	5.1%	7.3%
		Profit Attributable to Owners of the Parent Company		143.0	89.3	181.7
		Return on Equity (ROE)		7.4%	4.5%	8.4%
		Capital Expenditures		145.1	179.4	230.6
		Depreciation		193.1	180.6	181.1
		Ratio of Depreciation to Revenue		6.2%	5.7%	5.1%
		R&D Expenditure		290.1	298.4	335.5
		Ratio of R&D Expenditure to Revenue		9.3%	9.5%	9.4%
		Total Dividend Amount		37.1	37.1	51.2
		Amount of Treasury Stock Acquired		—	—	27.5
		Earnings per Share (EPS) (yen)		177.49	110.81	226.59
		Cash Dividends per Share (yen)		46	46	64
		Dividend Payout Ratio		25.9%	41.5%	28.2%
		Total Return Ratio		25.9%	41.5%	43.3%
		Stock Price (yen)		2,760	2,765	3,985
		Dividend Yield		1.7%	1.7%	1.6%
	Price Earnings Ratio (PER) (times)		15.5	25.0	17.6	
	Price Book-Value Ratio (PBR) (times)		1.1	1.1	1.4	
	Net Cash Provided by Operating Activities (A)		395.5	176.7	374.8	
	Net Cash Used in Investing Activities (B)		-327.9	-271.2	-269.2	
	Free Cash Flow (A+B)		67.6	-94.6	105.6	
	Net Cash Used in Financing Activities		-44.8	78.8	-98.5	
	Cash and Cash Equivalents at End of Year		688.6	665.4	707.3	
	Cash on Hand		933.6	1,022.1	1,095.2	
	Interest-Bearing Debt		399.6	523.1	507.5	
	Equity Attributable to Owners of the Parent Company		1,962.4	2,009.0	2,300.1	
	Total Assets		3,380.4	3,607.7	3,979.1	
	Ratio of Equity Attributable to Owners of the Parent Company to Total Assets		58.1%	55.7%	57.8%	
Non-Financial Data	Number of Employees		123,165	126,036	132,276	
	Local		59,549	62,100	67,525	
	Non-Consolidated		38,318	38,323	38,385	
	Ratio of Female Employees (Non-Consolidated)		—	—	11.4%	
	Number of Female Employees in Managerial Positions		—	—	30	
	Ratio of Female Employees in Managerial Positions		—	—	0.5%	
	Ratio of Local Employees in Leadership Roles at Overseas Bases		—	26%	30%	
	CO <sub>2</sub> Emissions per Unit*2 (Non-Consolidated) (%)		—	—	100	
	CO <sub>2</sub> Emissions per Unit*2 (Domestic and Overseas Group) (%)		—	—	100	
	In-House Power Generation Ratio (Non-Consolidated)*3		40.9%	40.7%	37.5%	
Exchange Rate (during FY)	USD (yen)		86	79	83	
	EUR (yen)		113	109	107	

\*1 The countries and regions included in "by region" have changed as follows.

Fiscal 2011–fiscal 2015: Japan, North America, Europe, Australia, and Others; fiscal 2016 and onward: Japan, North America, Europe, Asia, and Others

\*2 Per unit = CO<sub>2</sub> emissions/Revenue (indexed to fiscal 2013 as 100%)

\*3 Ratio of electricity generated through cogeneration to total electricity used

Billions of yen

IFRS							
2014	2015	2016	2017	2018	2019	2020	
4,095.0	4,309.8	4,524.5	4,527.1	5,108.3	5,362.8	5,153.5	
1,895.5	1,838.4	1,801.5	1,871.8	2,140.7	2,284.2	2,313.0	
799.4	942.3	1,081.1	1,050.5	1,122.8	1,182.0	1,145.2	
470.5	524.8	568.2	550.2	620.2	609.4	548.3	
855.4	930.8	1,014.7	989.5	1,146.0	1,215.1	1,086.9	
74.1	73.5	59.0	65.1	78.5	72.0	60.0	
3,639.5	3,830.7	4,048.2	4,061.8	4,521.4	4,762.3	4,558.7	
1,995.8	2,007.1	2,047.5	2,075.0	2,300.6	2,484.7	2,456.9	
48.7%	46.6%	45.3%	45.8%	45.0%	46.3%	47.7%	
455.5	479.1	476.3	465.3	586.9	600.5	594.8	
371.4	331.4	315.7	330.6	412.7	316.2	61.1	
9.1%	7.7%	7.0%	7.3%	8.1%	5.9%	1.2%	
277.2	258.4	244.3	257.6	320.6	254.5	68.1	
11.5%	8.4%	7.6%	8.0%	9.3%	7.1%	1.9%	
324.1	354.2	334.1	337.4	347.2	416.8	436.5	
197.2	220.1	236.8	241.1	268.6	287.3	302.1	
4.8%	5.1%	5.2%	5.3%	5.3%	5.4%	5.9%	
368.7	396.4	399.3	409.2	447.4	497.4	507.8	
9.0%	9.2%	8.8%	9.0%	8.8%	9.3%	9.9%	
83.7	87.7	95.3	94.6	101.4	108.9	108.5	
—	—	27.7	30.0	26.5	28.4	0.0	
348.05	324.01	307.19	326.32	410.45	326.47	87.89	
105	110	120	120	130	140	140	
30.2%	34.0%	39.1%	36.8%	31.7%	42.9%	159.3%	
30.2%	34.0%	50.4%	48.4%	39.9%	54.0%	159.3%	
4,948	5,483	4,524	4,897	5,820	4,317	3,491	
2.1%	2.0%	2.7%	2.5%	2.2%	3.2%	4.0%	
14.2	16.9	14.7	15.0	14.2	13.2	39.7	
1.5	1.3	1.1	1.2	1.3	0.9	0.8	
471.2	383.2	552.9	467.8	558.0	533.5	595.3	
-376.0	-111.5	-544.8	-108.0	-529.1	-514.7	-447.4	
95.2	271.7	8.0	359.7	28.9	18.8	147.9	
-176.0	-135.7	-104.7	-240.5	-40.3	-92.2	-240.9	
641.7	792.4	672.5	793.6	783.3	711.6	597.8	
1,034.1	944.0	876.7	858.4	918.3	880.8	711.6	
435.7	447.2	476.6	350.3	473.9	550.2	465.4	
2,799.9	3,327.9	3,123.6	3,312.7	3,598.3	3,595.7	3,397.1	
4,642.1	5,283.3	5,042.9	5,150.8	5,764.4	5,792.4	5,651.8	
60.3%	63.0%	61.9%	64.3%	62.4%	62.1%	60.1%	
139,842	146,714	151,775	154,493	168,813	171,992	170,932	
74,289	81,060	85,464	86,892	94,209	95,222	93,343	
38,581	38,493	38,489	38,914	39,315	45,304	45,280	
11.6%	11.9%	12.3%	12.7%	13.1%	13.9%	14.2%	
33	40	46	53	61	86	103	
0.5%	0.6%	0.7%	0.8%	0.9%	1.1%	1.3%	
31%	33%	33%	33%	28%	32%	30%	
99	97	88	80	75	68	63	
85	80	76	73	68	65	60	
34.3%	32.9%	38.0%	43.9%	45.5%	45.6%	46.0%	
100	110	120	108	111	111	109	
134	139	133	119	130	128	121	

## Company Overview and Stock Information

(As of March 31, 2020)

### Company Profile

Company Name	DENSO CORPORATION
Established	December 16, 1949
Capital	¥187.5 billion
Head Office	1-1, Showa-cho, Kariya, Aichi 448-8661, Japan
Employees	Consolidated basis: 170,932 Non-consolidated basis: 45,280
Consolidated Subsidiaries	200 (Japan 64, North America 23, Europe 32, Asia 74, Others 7)
Companies Accounted for by the Equity Method	88 (Japan 24, North America 11, Europe 17, Asia 32, Others 4)
Fiscal Year	From April 1 to March 31
Ordinary General Meeting of Shareholders	June
Share Trading Unit	100 shares
Number of Shares Issued	787,944,951 shares (excluding DENSO CORPORATION owning 13,041,350 shares of treasury stock)
Number of Shareholders	84,955 (including DENSO CORPORATION owning treasury stock)
Securities Identification Code	6902
Stock Exchange Listings	Tokyo, Nagoya

### Principal Shareholders (Leading 10 Principal Shareholders)

	Number of shares held (thousands)	Voting share (%)
Toyota Motor Corporation	188,949	24.38
Toyota Industries Corporation	69,373	8.95
The Master Trust Bank of Japan, Ltd. (Trust Account)	51,978	6.70
Towa Real Estate Co., Ltd.	33,309	4.29
Japan Trustee Services Bank, Ltd. (Trust Account)	32,251	4.16
Nippon Life Insurance Company (Standing proxy: The Master Trust Bank of Japan, Ltd.)	21,645	2.79
DENSO Employees' Shareholding Association	14,128	1.82
Aisin Seiki Co., Ltd.	12,518	1.61
Japan Trustee Services Bank, Ltd. (Trust Account 7)	10,218	1.31
Japan Trustee Services Bank, Ltd. (Trust Account 5)	8,968	1.15

### Overview of DENSO's Corporate Website

<https://www.denso.com/global/en/>



### Breakdown of Shareholders

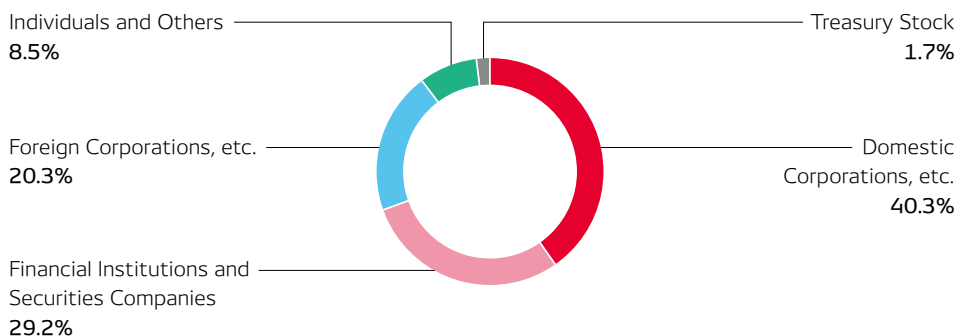

### Trend in TSR\*

TSR (Cumulative / Annual Rate)

Investment period	1 year		3 years		5 years		10 years	
	Cumulative / Annual rate	Cumulative	Annual rate	Cumulative	Annual rate	Cumulative	Annual rate	
DENSO	-15.9%	-20.3%	-7.3%	-24.5%	-5.5%	62.0%	4.9%	
TOPIX	-9.5%	-0.4%	-0.1%	1.8%	0.4%	78.4%	6.0%	
TOPIX (Transportation equipment)	-15.1%	-15.1%	-5.3%	-25.8%	-5.8%	58.0%	4.7%	

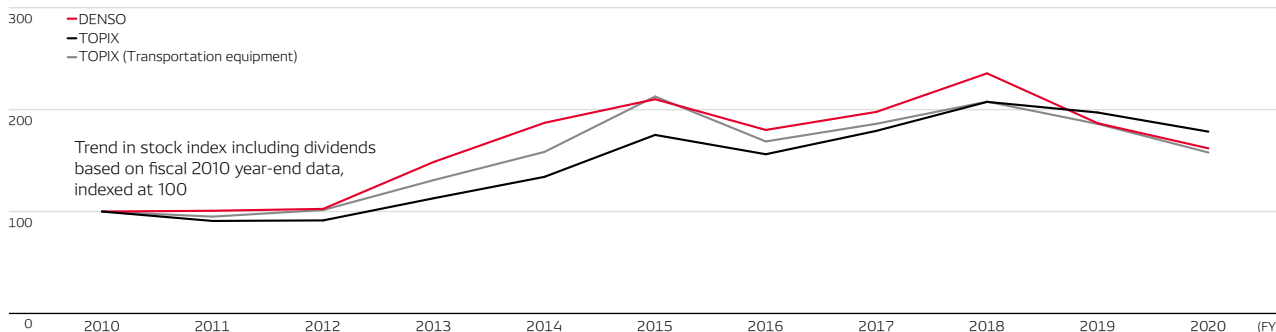

\* Total shareholder return: Total return on investment that combines capital gains and dividends

### Stock Price Range and Trading Volume (Tokyo Stock Exchange)

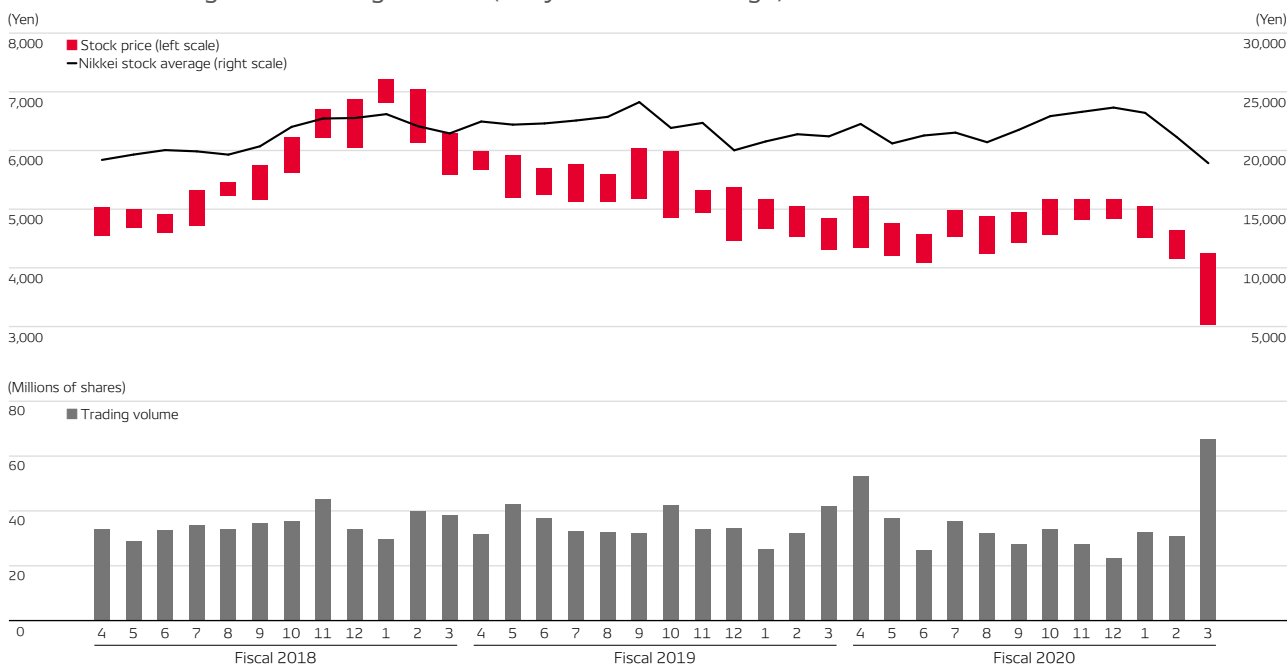

## **DENSO CORPORATION**

1-1, Showa-cho, Kariya, Aichi 448-8661, Japan  
Phone: +81-566-25-5511 (Information Center)  
[www.denso.com/global/en/](http://www.denso.com/global/en/)